

TD32/TD40 PAL

USER'S GUIDE



Foreword

- Caution 3
- Important Safety Information 5

Overviewing your the Monitor

- Viewing the Control Panel 9
- Viewing the Connecting Panel 10
- Viewing the Remote Control
 - Key Description 12
 - Teletext / PIP(Picture In Picture) 13
 - Loading the Batteries 15

Installation

- Table Stand Installation 16
- Speaker Installation 17

Connection the Cable/Devices

- Connecting the TV Cable 18
- Connecting the VCR 19
- Connecting the DVD 20
- Connecting the Set Top Box 21
- Connecting the PC [D-Sub & DVI] 22
 - Displayable Monitor Specification 23

Setting the Channel

- Basic Operation 24
- OSD Menu Structure 25
- Storing Channels Automatically 26
- Storing Channels Manually 28
- Fine Tuning the Channel Reception 28
- Editing the Channels 29
- Digest Function 30
- Teletext 31

Contents

Setting the Picture

■ Changing the Picture Mode	32
■ Adjusting the User Mode	33
■ Changing the Color Temperature	35
■ Video NR (Noise Reduction)	36
■ Changing the Screen Format	36
■ Adjusting the PC Screen (Geometry)	38

Setting the Sound

■ Adjusting the Sound Balance	40
■ Changing the Sound Mode	40
■ Adjusting User Sound mode	41
■ Spatial Effect	41
■ AVC (Auto Volume Control)	41
■ MTS (Multichannel Television Sound)	42

Setting the Others

■ Adjusting the Transparency of the OSD Window	43
■ PIP (Picture In Picture)	43
- Changing the Size in PIP	44
- Choosing the Source in PIP	44
- Picture Swap in PIP	45
- Changing the Position in PIP	45
■ Other Advanced Function	
- Set ID	46
- Setting the Blue Screen Mode	47
- Changing the OSD Language	47
- Front Key Lock in Advance	47



Setting the Time

■ Setting the Current Time	48
■ Setting the On Time	48
■ Setting the Off Time	50
■ Setting the Sleep Timer	50

<u>Troubleshooting</u>	51
-------------------------------------	----

<u>Warranty Card</u>	52
-----------------------------------	----

Caution

	CAUTION RISK OF ELECTRIC SHOCK DO NOT OPEN	
CAUTION : TO REDUCE THE RISK OF ELECTRIC SHOCK, DO NOT REMOVE COVER (OR BACK), NO USER-SERVICEABLE PARTS INSIDE. REFER SERVICING TO QUALIFIED SERVICE PERSONNEL.		



This symbol is intended to alert the user to the presence of uninsulated "dangerous voltage" within the product's enclosure that may be of sufficient magnitude to constitute a risk of electric shock to persons.



This symbol is intended to alert the user to the presence of important operating and maintenance(servicing) instructions in the literature accompanying the appliance.

CAUTION
- TO PREVENT DAMAGE WHICH MAY RESULT IN FIRE OR SHOCK HAZARD. - DO NOT EXPOSE THIS APPLIANCE TO RAIN OR MOISTURE. - SHOCK HAZARD DO NOT OPEN.

CAUTION
These servicing instructions are for use by qualified service personnel only. To reduce the risk of electric shock, do not perform any servicing other than that contained in the operating instructions unless you are qualified to do so.

CAUTION
The stand is intended for use with this monitor only. Use with other products may result in injury.

WARNING
- Apparatus shall not be exposed to dripping or splashing and no objects filled with liquids, such as vases, shall be placed on the apparatus. - This is Class B product. In a domestic environment this product may cause radio interference in which case the user may be required to take adequate measures. - To reduce the risk of fire and electric shock, do not expose this product to rain or moisture.

FCC NOTICE
This device has been tested and found to comply with the limits for a Class B device, pursuant to Part 15 of the FCC Rules. These limits are designed to provide reasonable protection against harmful interference in home environment as well as in a commercial, industrial or business environment. This equipment can generate, use and radiate radio frequency energy and, if not installed and used in accordance with the instruction, may cause harmful interference to radio communications. However, there is no guarantee that interference will not occur in a particular installation. If this equipment does cause harmful interference to radio or television reception, which can be determined by turning the equipment off and on, the user is encouraged to try to correct the interference by one or more of the following measures :
- Reorient or relocate the receiving antenna. - Increase the separation between the equipment and receiver. - Connect the equipment into an outlet on a circuit different from that to which the receiver is connected. - Consult the dealer or an experienced radio/TV technician for help.
Changes or modification not expressly approved by the party responsible for compliance could void the user's authority to operate the equipment. Connecting of peripherals requires the use of grounded shielded signal cables.

▶ **Always be careful when using your the Monitor. To reduce the risk of fire, electrical shock, and other injuries, keep these safety precautions in mind when installing, using, and maintaining your machine.**

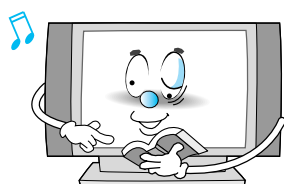

Read all safety and operating instructions before operating your the Monitor.

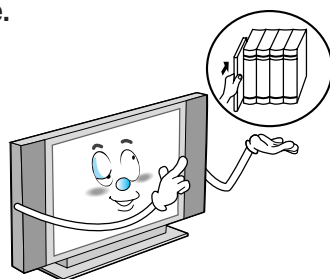

Keep the safety and operating instructions for future reference.

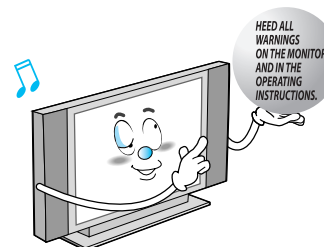

Heed all warnings on the Monitor and in the operating instructions.

Caution

Always be careful when using your the Monitor. To reduce the risk of fire, electrical shock, and other injuries, keep these safety precautions in mind when installing, using, and maintaining your machine.

1. Read these instructions.
2. Keep these instructions.
3. Heed all warnings.
4. Follow all instructions.
5. Do not use this apparatus near water.
6. Clean only with a damp cloth.
7. Do not block any of the ventilation openings. Install in accordance with the manufacturer's instructions.
8. Do not install near any heat sources such as radiators, heat registers, stoves, or other apparatus (including amplifiers) that produce heat.
9. Do not defeat the safety purpose of the polarized or grounding type plug. A polarized plug has two blades with one wider than the other. A grounding type plug has two blades and a third grounding prong. The wide blade or the third prong is provided for your safety. When the provided plug does not fit into your outlet, consult an electrician for replacement of the obsolete outlet.
10. Protect the power cord from being walked on or pinched particularly at plugs, convenience receptacles, and the point where they exit from the apparatus.
11. Only use the attachments/accessories specified by the manufacturer.
12. Use only with a cart, stand, tripod, bracket, or table specified by the manufacturer, or sold with the apparatus. When a cart is used, use caution when moving the cart/apparatus combination to avoid injury from tip-over.



13. Unplug this apparatus during lightning storms or when unused for long periods of time.
14. Refer all servicing to qualified service personnel. Servicing is required when the apparatus has been damaged in any way, such as power supply cord or plug is damaged, liquid has been spilled or objects have fallen into the apparatus, the apparatus has been exposed to rain or moisture, does not operate normally, or has been dropped.

Important Safety Information

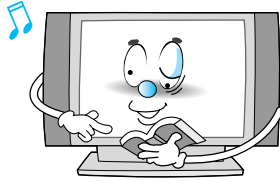

Follow all operating and use instructions.

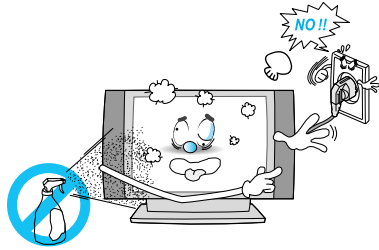

Unplug the Monitor from the wall outlet before cleaning. Use a damp cloth; do not use liquid or aerosol cleaners.

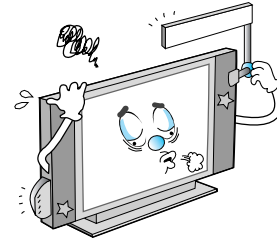

Never add any attachments and/or equipment without approval of the manufacturer. Such additions can increase the risk of fire, electric shock, or other personal injury.



Do not use the Monitor where contact with or immersion in water is a possibility, such as near bath tubs, sinks, washing machines, swimming pools, etc.

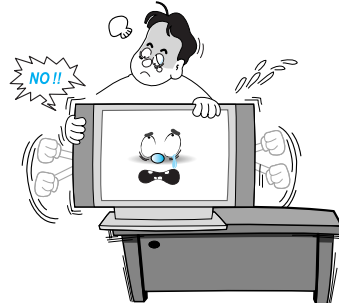

When installing the Monitor on a table, be careful not to place it too close to the edge of the table.
- This may cause the Monitor to fall, causing serious injury to a child or adult, and serious damage to the Monitor.

Important Safety Information

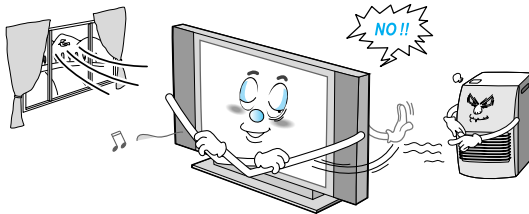

Provide ventilation for the Monitor. The unit is designed with slots in the cabinet for ventilation to protect it from overheating. Do not block these openings with any object, and do not place the Monitor on a bed, sofa, rug or other similar surface. Do not place it near a radiator or heat register. If you place the Monitor on a rack or bookcase, ensure that there is adequate ventilation and that you've followed the manufacturer's instructions for mounting.

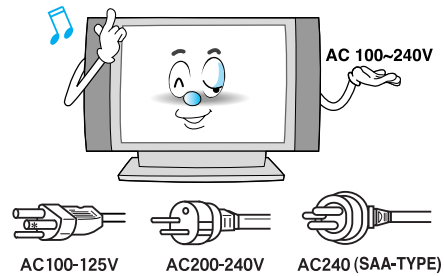

Use only the accessory cord designed for this product to prevent shock. The power supply voltage rating of this product is AC100-240V, the power cord attached conforms to the following power supply voltage. Use only the power cord designated by our dealer to ensure Safety and EMC. When it is used by other power supply voltage, power cable must be changed. Consult your product dealer.

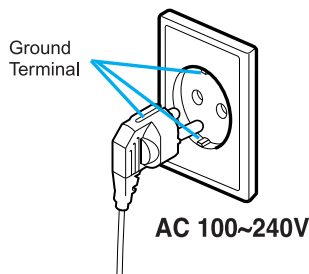

Use only a grounded or polarized outlet. For your safety, this Monitor is equipped with a polarized alternating current line plug having one blade wider than the other. This plug will fit into the power outlet only one way. If you are unable to insert the plug fully into the outlet, try reversing the plug. If the plug still does not fit, contact your electrician to replace your outlet.

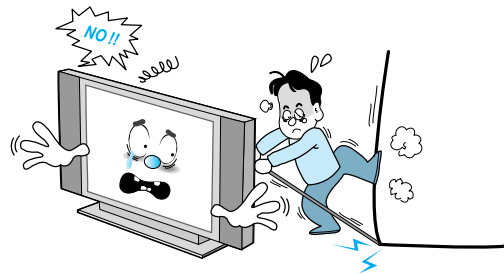

Avoid overhead power lines. An outside antenna system should not be placed in the vicinity of overhead power lines or other electric light or power circuits or where it can fall into such power lines or circuits. When installing an outside antenna system, be extremely careful to keep from touching the power lines or circuits. Contact with such lines can be fatal.

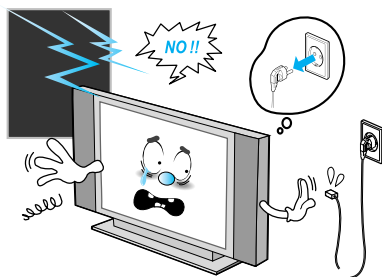

Unplug the Monitor from the wall outlet and disconnect the antenna or cable system during a lightning storm or when left unattended and unused for long periods of time. This will prevent damage to the unit due to lightning and power-line surges.

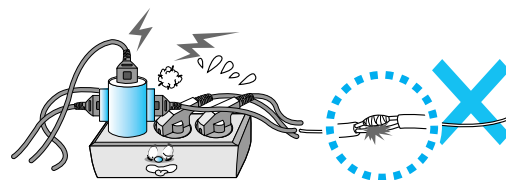

Protect the power cord. Power supply cords should be routed so that they won't be walked on or pinched by objects placed on or against them. Pay particular attention to cords at plugs, convenience receptacles, and the point where they exit from the unit.

Important Safety Information

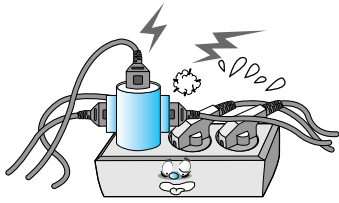

Do not overload the wall outlet or extension cords. Overloading can result in fire or electric shock.

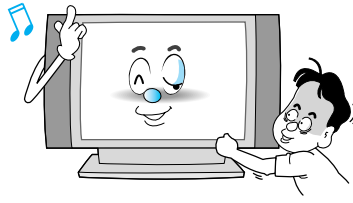

Do not insert anything through the openings in the unit, where they can touch dangerous voltage points or damage parts. Never spill liquid of any kind on the Monitor.

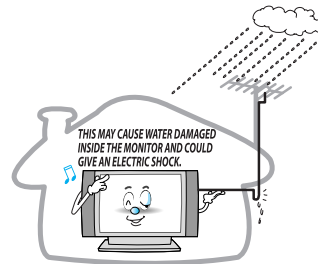

Bend antenna cable between inside and outside building to prevent rain from flowing in.

- This may cause water damaged inside the Monitor and could give an electric shock.

Ground outdoor antennas. If an outside antenna or cable system is connected to the Monitor, be sure the antenna or cable system is grounded so as to provide some protection against voltage surges and built-up static charges. Section 810 of the National Electrical Code, ANSI/NFPA No.70-1984, provides information about proper grounding of the mast and supporting structure, grounding of the lead-in wire to an antenna discharge unit, size of grounding conductors, location of antenna discharge unit, connection to grounding electrodes, and requirements for the grounding electrode.

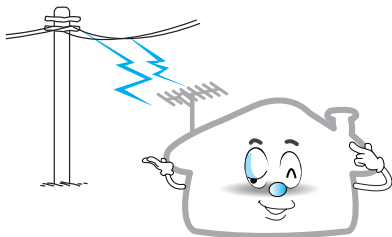

Do not place an outside antenna in the vicinity of overhead power lines or other electric light or power circuits.

- This may cause an electric shock.

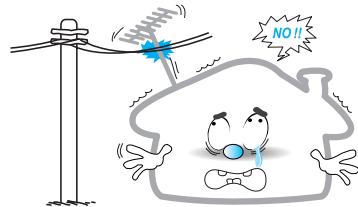

There should be enough distance between an outside antenna and power lines to keep the former from touching the latter even when the antenna falls.

- This may cause an electric shock.

Do not attempt to service the Monitor yourself. Refer all servicing to qualified service personnel. Unplug the unit from the wall outlet and refer servicing to qualified service personnel under the following conditions:

- when the power-supply cord or plug is damaged
- if liquid has been spilled on the unit or if objects have fallen into the unit
- if the Monitor has been exposed to rain or water
- if the Monitor does not operate normally by following the operating instructions
- if the Monitor has been dropped or the cabinet has been damaged
- when the Monitor exhibits a distinct change in performance

Important Safety Information

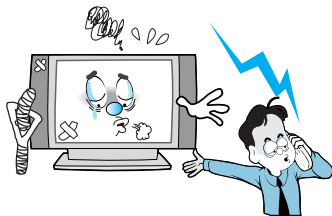

When replacement parts are required, be sure the service technician uses replacement parts specified by the manufacturer or those that have the same characteristics as the original part. Unauthorized substitutions may result in additional damage to the unit.

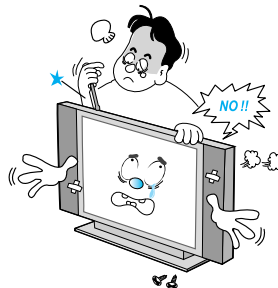

Upon completion of any service or repairs to this the Monitor, ask the service technician to perform safety checks to determine that the Monitor is in a safe operating condition.

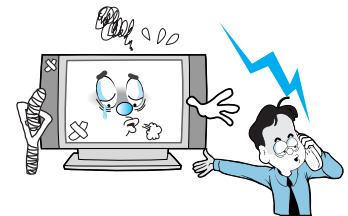

If you make adjustments yourself, adjust only those controls that are covered by the operating instructions. Adjusting other controls may result in damage and will often require extensive work by a qualified technician to restore the Monitor to normal.

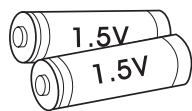

Only use the specified batteries.

- This may cause damage to the Monitor or could give an electric shock.

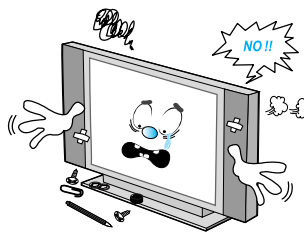

Do not place anything containing liquid on top of the Monitor.

- This may cause a fire or could give an electric shock.

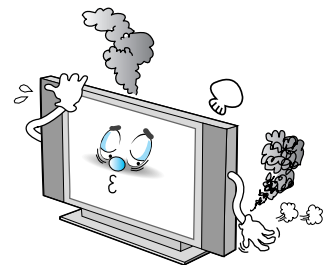

In case of smoke or strange smell from the Monitor, switch it off, unplug it from the wall outlet and contact your dealer or service center.

- This may cause a fire or could give an electric shock.

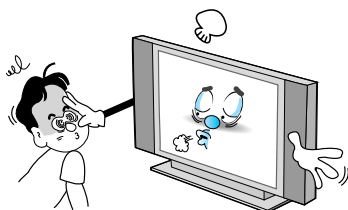

The viewing distance should be about 5~7 times as long as diagonal length of the screen.

- If not, eyes will strain.

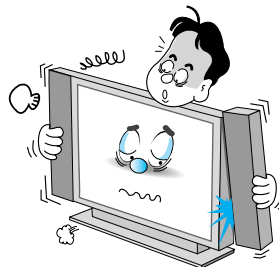

When moving the Monitor assembled with speakers do not carry holding the speakers.

- This may cause the Monitor to fall, causing serious injury to a child or adult, and serious damage to the Monitor.

Viewing the Control Panel

OSD Key Position

Front Panel

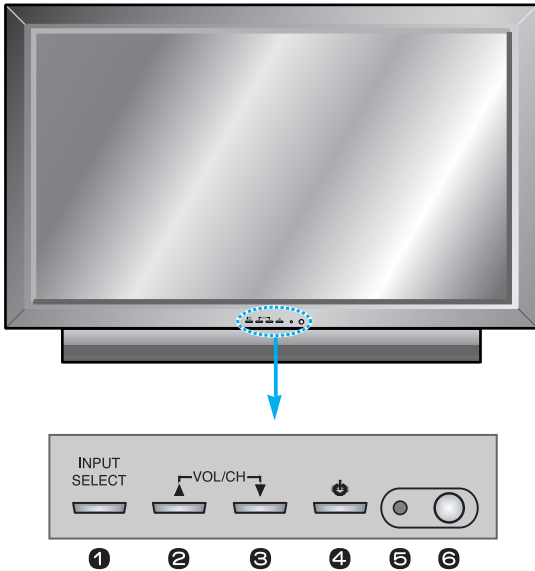

▶ OSD key & Function

- ❶ Input Source Select
- ❷ UP
- ❸ DOWN (See the box below.)
- ❹ Power (Stand By)
- ❺ Remote Sensor.
- ❻ Status / Power Indicator LED

OSD Key Function

▶ INPUT SELECT

Select the signal source from multiple input sources such as TV, SCART 1, SCART 2, S-Video / AV, Component1, Component2, PC and DVI.

▶ VOL/CH▲/▼

To change the CHANNEL, Press ▼ key first and change the CHANNEL with ▲, ▼ keys.
To change the VOLUME, Press ▲ key first and change the VOLUME with ▲, ▼ keys.

▶ ⏻ Power On /Off

Turn the Monitor on and off.

Accessories



Remote Control Handset



Power Cord

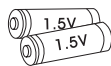

RF Cable

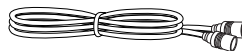

Alkaline Batteries

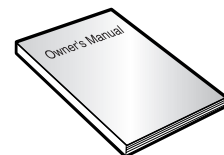

Owner's Manual

Viewing the Connecting Panel

Back Panel and Jacks

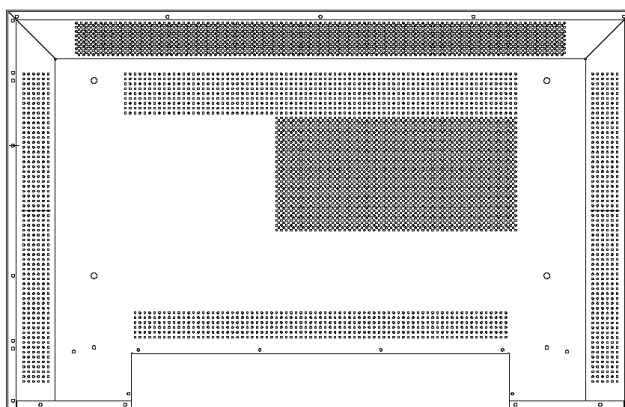

< Back panel of the monitor >

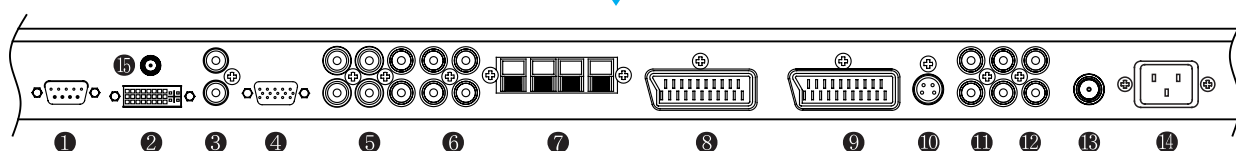
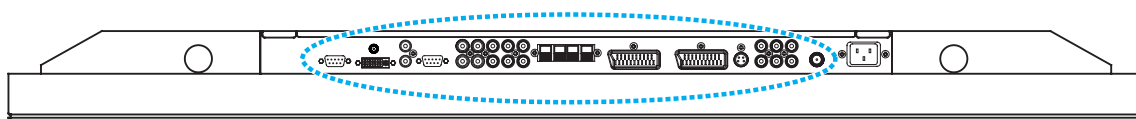

①	RS-232C	To control from PC.
②	DVI	For PC, Set top box.
③	Speakers	PC/DVI Audio Input.
④	D-Sub (PC)	For PC, Set top box.
⑤	Component 1, 2	For DVD, Set top box.
⑥	Component Sound	For Component Audio Input.
⑦	Speakers	To connect speakers (2CH, Stereo)
⑧	SCART 1 (Euro connector)	For VCR, DVD, Set top box.
⑨	SCART 2 (Euro connector)	For VCR, DVD, Set top box.
⑩	S-Video	For DVD, Set top box, S-VHS.
⑪	AV Output	To connect other TV or monitor.
⑫	AV Input	For VCR, DVD, Set top box.
⑬	TV Antenna	For TV antenna cable. (Air)
⑭	AC Power	
⑮	DC 5V OUTPUT	

• Refer to the next page for port descriptions.

Viewing the Connecting Panel

- 1 RS-232C Jack**
 Connects a control signal from a PC.
- 2 DVI INPUT JACK**
 Connects a digital video signal from a DVI output jack of PC or Set Top box.
- 4 RGB PC INPUT JACK (D-SUB)**
 Connects a video signal from a video output jack of PC.
 Cables connecting the PC vary according to the type of machine, so contact your product dealer.
- 5 COMPONENT INPUT JACK 1, 2**
 Connects a three separate component video signal from a component output jack of a DVD player or Set Top box.
 Supports 480i/60Hz, 480p/60Hz, 576i/50Hz, 576p/50Hz, 720p/60Hz, 1080i/50Hz, 1080i/60Hz signals.
 (i: interlace, p: progressive)
- 6 COMPONENT SOUND**
 Connects a sound signal from component.
- 7 SCART (EURO CONNECTOR) JACK 1, 2**
 - SCART 1: Half SCART (CVBS only input / output).
 - SCART 2: Full SCART (CVBS & RGB input / output).
 Connects a SCART (euro cable) signal from a VCR, DVD player, or Set Top Box.
- 9 S-VIDEO INPUT JACK**
 Connects a S-Video video signals from a S-Video output jack of a S-VHS, VCR or DVD player.
- 10 COMPOSITE (RCA) OUTPUT JACK**
 Output the signal of the current screen of the Monitor. Connects to other TV or monitor.
- 11 COMPOSITE (RCA) INPUT JACK**
 Connects an AV composite video signal from a composite output terminal of a VCR or DVD player.
 Unavailable when a S-Video cable is put into the S-Video input jack.
- 12 ANT. IN (TV ANTENNA JACK)**
 Connects to an TV antenna cable.
- 13 AC (POWER) INPUT JACK**
 Firmly insert the accessory power cord as far as it will go into the power input terminal.
 Firmly push the power cord plug as far as it will go into the power socket.

Connectors	
AUDIO INPUT	RCA Pin Jack
VIDEO INPUT	21 Pin Euro AV (SCART)
VIDEO INPUT	21 Pin Euro AV (SCART)
S-VIDEO INPUT	Mini Din 4 Pin
COMPONENT VIDEO INPUT	RCA Pin Jack
ANALOG RGB INPUT	Mini D-Sub 15pin
DIGITAL VIDEO INPUT	DVI-D 24 pin

• Cables connecting the PC vary according to the type of machine, so consult your product dealer.

RS-232C Configurations

3-Wire (Non-standard)

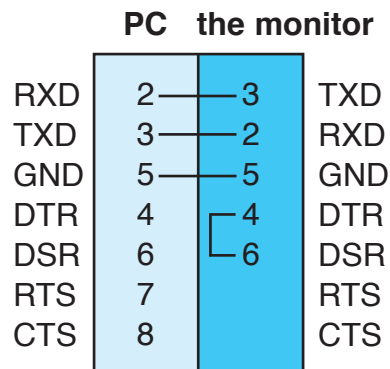

Viewing the Remote Control

Key Description

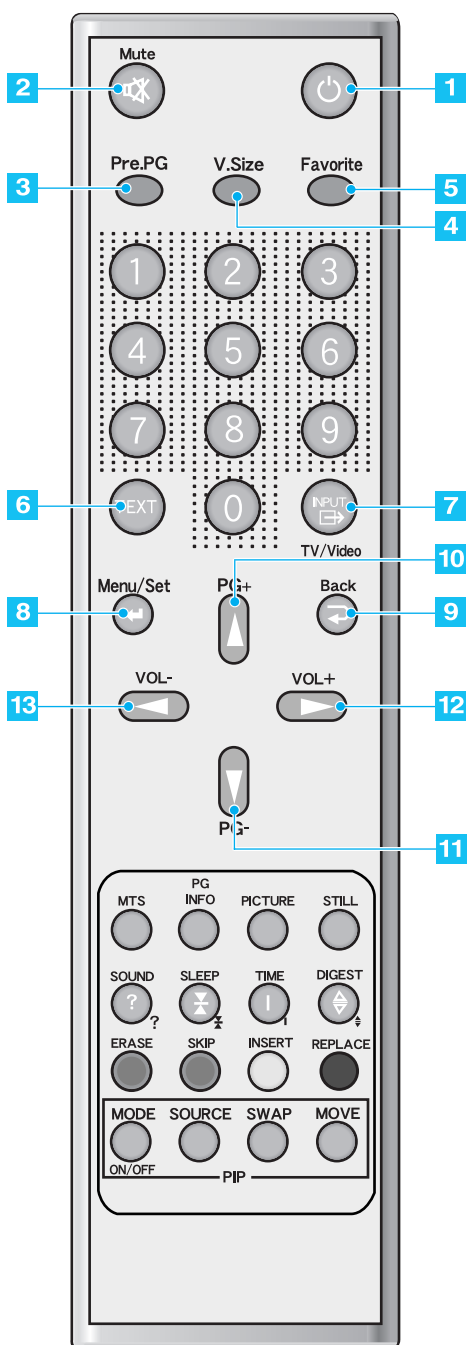

- 1 Power**
Turn the Monitor on and off.
- 2 Mute**
Temporarily cut the sound and restore it.
- 3 Pre PG**
Turn to the previous program or exit OSD.
- 4 V.Size**
Choose the Screen Format.
Wide → Panorama → Zoom1 → Zoom2 → 4:3
- 5 FAVORITE (FAVOURITE)**
Tune to your next favorite program.
- 6 TEXT**
Teletext on / off.
TTX → TTX/MIX → Normal (TTX off)
- 7 INPUT**
Display the input source list.
- 8 Menu / Set**
Display the main OSD menu.
Activate your choice in the OSD menu.
- 9 Back**
Return to the previous OSD menu.
- 10 PG+**
Move to the upper program.
- 11 PG-**
Move to the lower program.
- 12 VOL+**
Increase the volume level.
- 13 VOL-**
Decrease the volume level.

Viewing the Connecting Panel

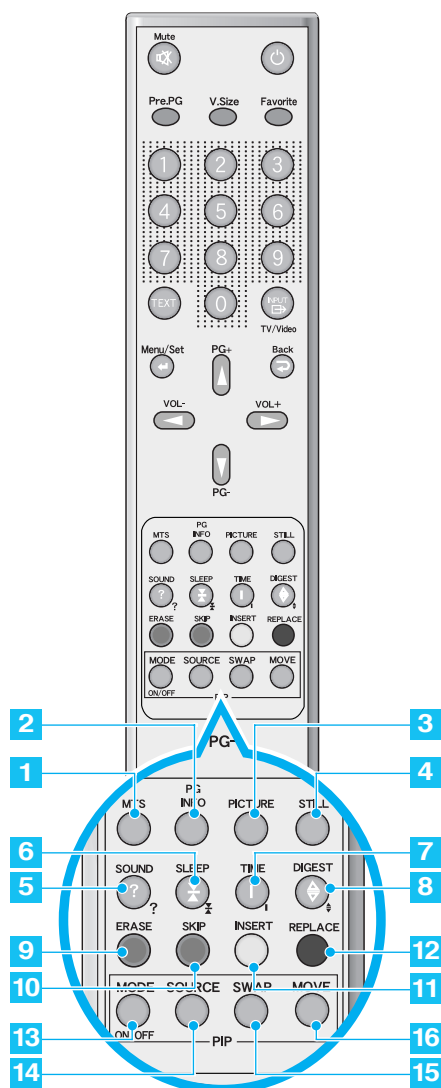

- 1 MTS**
Choose the MTS (Stereo) mode. Each time it is pressed, different mode is selected.
Mono → Stereo → Language A → Language B → Language AB
• You can select only available modes depending on the source.
- 2 PG INFO**
Display the current information about time, Screen Format, source and MTS mode.
- 3 PICTURE**
There are 4 picture modes.
Standard → Vivid → Mild → User
- 4 STILL**
Temporarily freeze the screen and restore it.
- 5 SOUND**
Choose the sound equalizer settings.
Standard → Movie → Music → News → User
- 6 SLEEP**
Set the preset time interval for automatic turn-off.
OFF → 10 → 20 → 30 → 60 → 90 → 120 → 150 → 180
- 7 TIME**
Display the current time on the screen.
- 8 DIGEST**
Display 15 TV programs at the same time.

▶ TTX / program Edit keys

- 9 ERASE**
Erase the current program.
- 10 SKIP**
Make the program skipped.
- 11 INSERT**
Add the current program.
- 12 REPLACE**
Replace the selected program with the current program.
• See 34 page.
• These keys are the colour keys in TTX also.

▶ PIP (Picture In Picture) Keys

- 13 MODE (On / Off)**
Activate PIP function and change the PIP window size and PIP mode.
Small → Large → Twin (Half) → OFF
- 14 SOURCE**
Change the PIP window source.
- 15 SWAP**
Swap the main screen and the PIP window.
- 16 MOVE**
Move the position of the PIP window.

Viewing the Remote Control

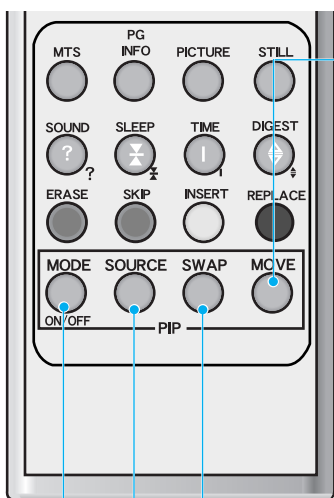

Move key : Move the position of PIP window.

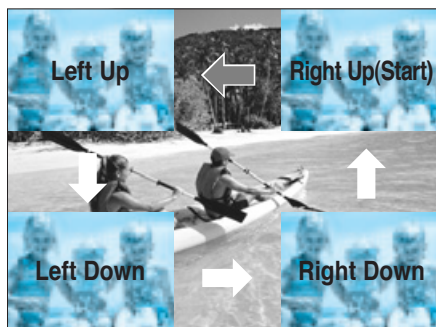

Swap key : Swap the sources of the main screen and PIP window.

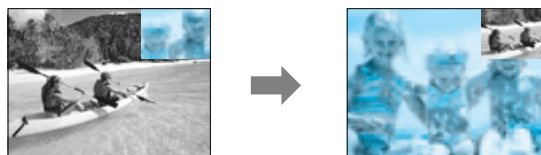

MODE KEY : Change the PIP window mode.
OFF → SMALL → LARGE → TWIN

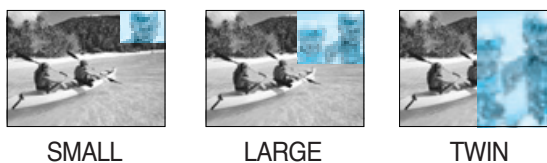

Source key : Change the source of the PIP window. The available sources are shown as below.

PIP \ Main	TV	SCART1	SCART1	S-Video/AV	Component1	Component2	PC	DVI
TV	✓	✓	✓	✓	✓	✓	✓	✓
SCART	✓	-	✓	✓	✓	✓	✓	✓
SCART 2	✓	✓	-	✓	✓	✓	✓	✓
S-Video	✓	✓	✓	-	✓	✓	✓	✓
Component1	✓	✓	✓	✓	-	-	-	-
Component2	✓	✓	✓	✓	-	-	-	-
PC	✓	✓	✓	✓	-	-	-	-
DVI	✓	✓	✓	✓	-	-	-	-

Viewing the Remote Control

Loading the Batteries

- 1 Press on the cover and slide in the direction of the arrow.
- 2 Load two AAA batteries, taking care that the + and - ends face the correct direction.
- 3 Close the cover until it clicks.

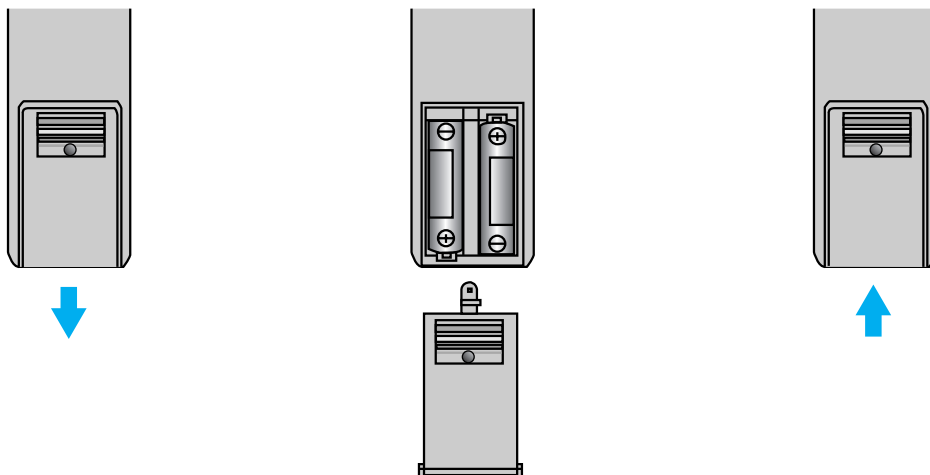

Reception range of remote control

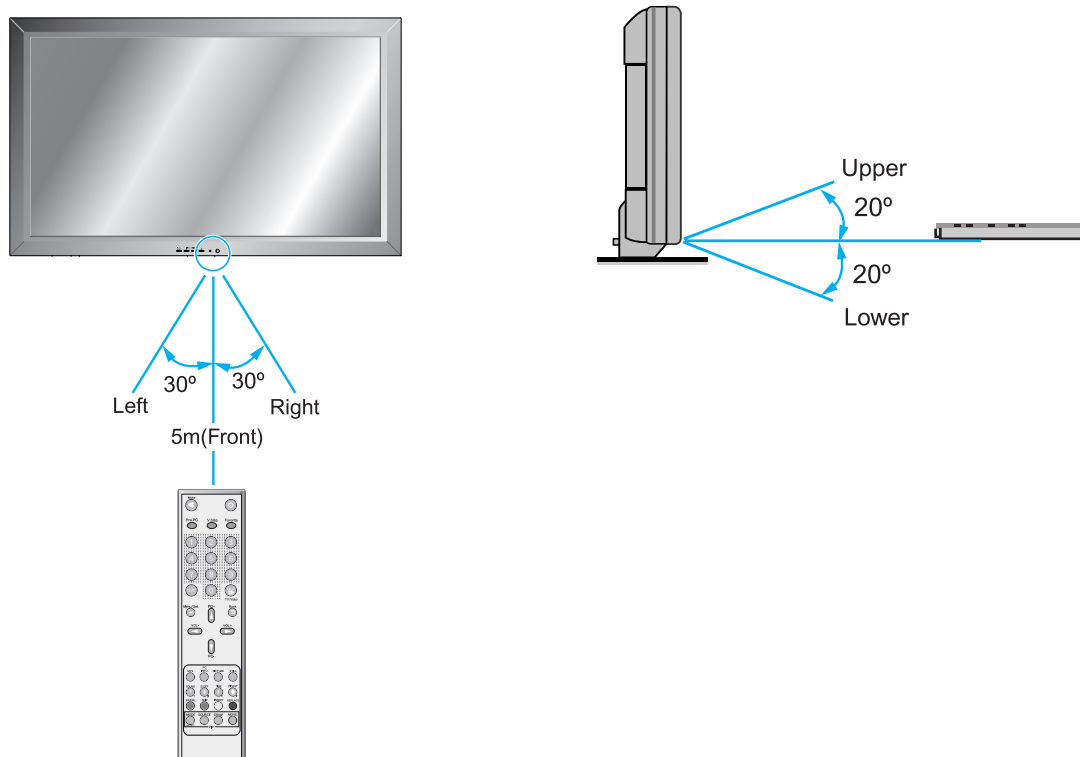

Installation

Table Stand Installation (optional)



< The Monitor can be installed on the desk as shown above. >

- Table Stand mount minimum allowable clearances for adequate ventilation.

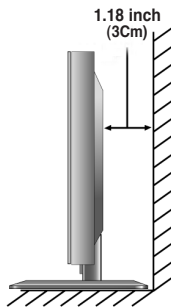
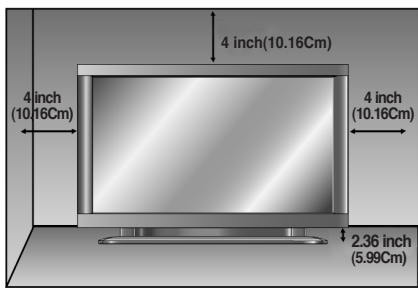

Installation

Table-Stand User's Guide

① Insert Stand Bars into the Stand Base as shown below

② (a) – Secure with Screw A (8 x 18)

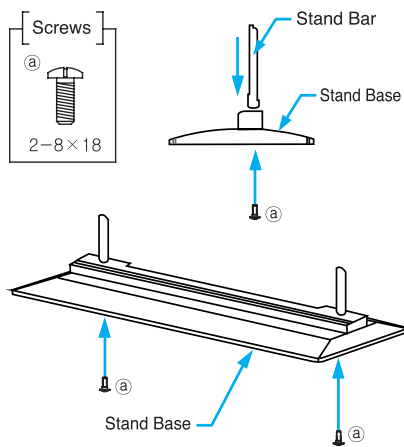

③ Insert a Stand-Table as below

④ (b) – Secure with Screw B (4 x 30)

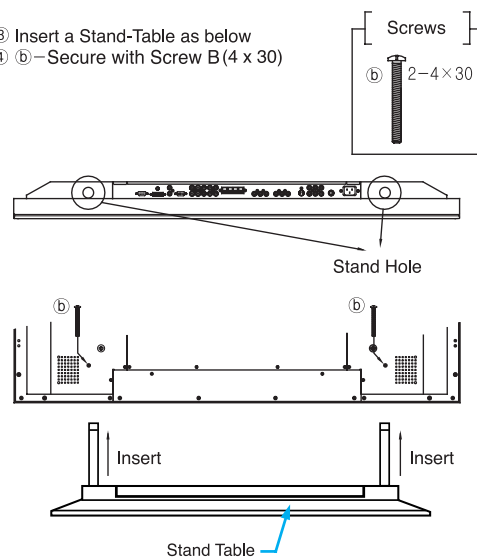

Speaker Installation (optional)

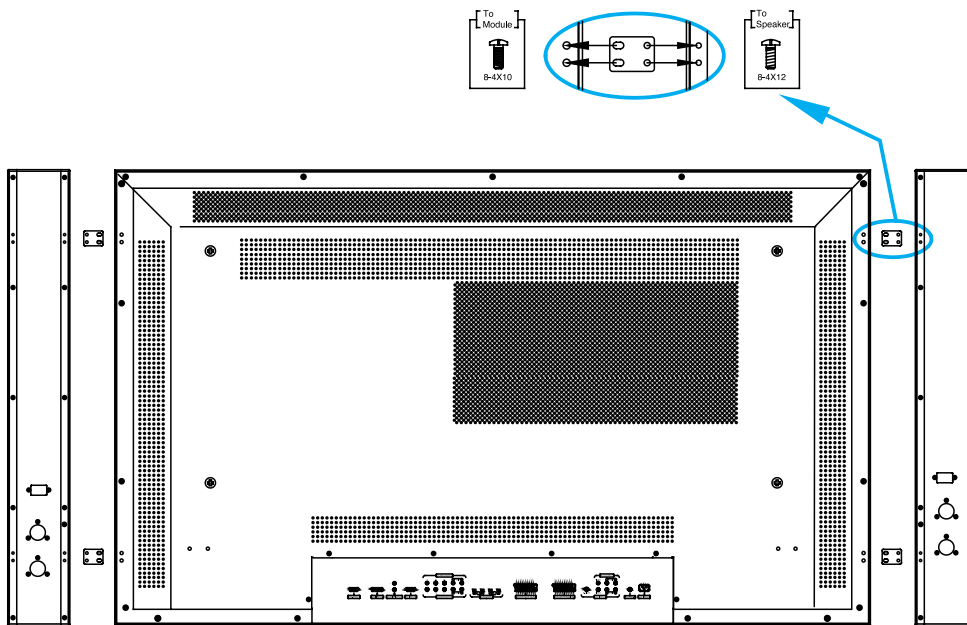

Caution

- **Be sure monitor power is turned off before making any connections.**
Place the speakers in the position you want. Install the speaker wires on the monitor and speaker. Be sure to connect the positive "+" wire to the "+" input and the negative "-" wire to the "-" input. Connect left monitor input to left speaker and right monitor input to right speaker. Any extra speaker wire length remaining can be bunched into the wire holders provided. (Caution: Once installed, the speaker wire holders lock into position and can't be removed.)
- **Always lift the monitor itself (not the speakers) when handling or moving the monitor after speakers have been installed.**

► Speaker Accessories



4-Iron Plates
(Mount speakers to monitor)

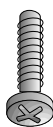

8-4 x 16 Long Bolts
(Attach iron plates to speakers)

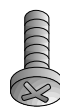

8-4 x 8 Short Bolts
(Attach iron plates to monitor)



2-Speaker Wires

Connecting the TV Cable

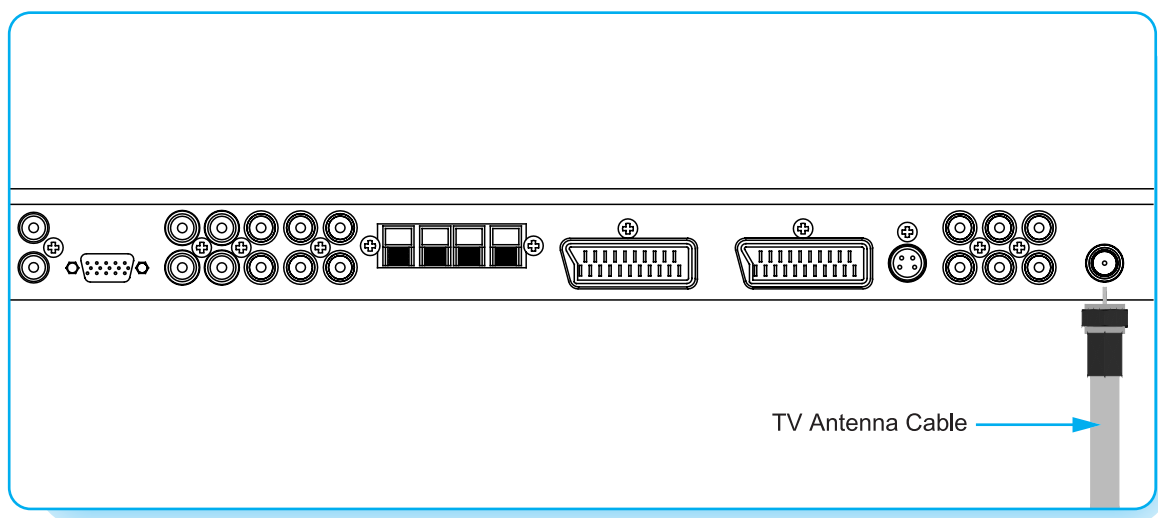

Connecting the TV Cable

- 1 Connect the TV Antenna cable to the TV input jack. Press INPUT button on the remote control and select TV on OSD.
- 2 Use PG+, PG- button or numeric button to change TV program for your program selection.
- 3 Press Pre PG button on the remote control to tune the previous program.
- 4 Also, you can tune to cable service provided programs using the cable box. For further information regarding cable TV service, contact cable TV service provider(s).

Connecting the VCR

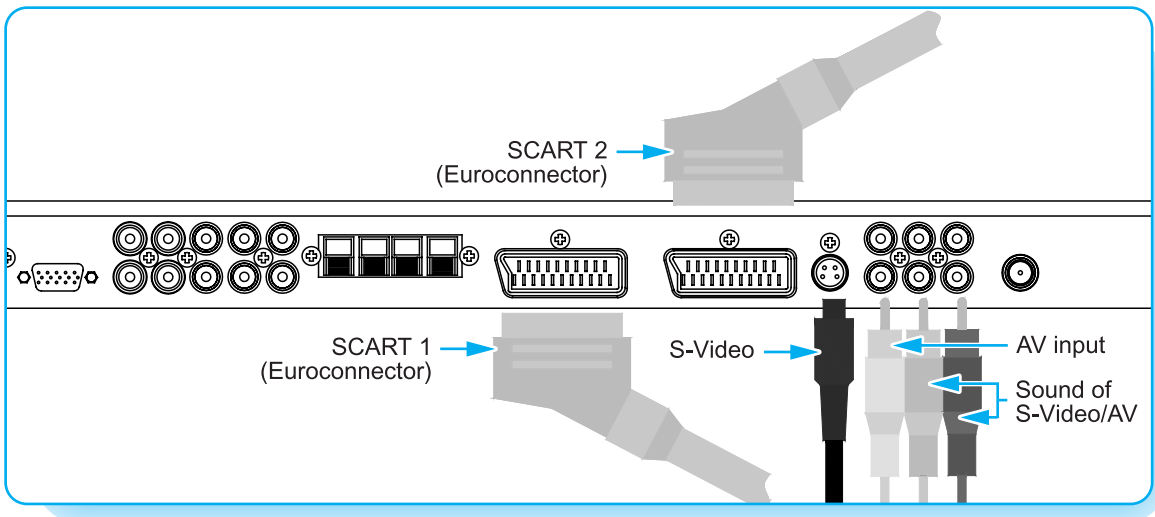

Connecting the VCR

With SCART (Euro cable)

Connect a SCART cable to the SCART jacks of the VCR and the Monitor.

With S-Video

Connect a S-Video cable to the S-Video jacks of the VCR and the Monitor.

Connect L (White), R (Red) sound cable (composite) to the sound jacks of the VCR and the Monitor.

With AV input

Connect a composite cable to the AV video jacks of the VCR and the Monitor.

Connect L (White), R (Red) sound cable (composite) to the sound jacks of the VCR and the Monitor.

Watching VCR

1 Press INPUT button on the remote control and select Video Sources.

2 Insert a video tape into the VCR and press the PLAY key on the VCR.



Notes

- To avoid picture noise (interference), leave an adequate distance (over 3m) between the VCR and monitor.
- When connecting the Monitor with external equipment, match the colour of connecting ports (e.g. Video - yellow, Audio(L) - white, Audio(R) - red).
- If you have a mono VCR, connect the audio cable from the VCR to the AUDIO(L/MONO) input of the Monitor.
- If you connect an S-VHS VCR to the S-VIDEO input socket, you can get a better picture quality than normal video input (AV).

Connecting the DVD

Connecting the DVD

- Connect the three separate component video cables to the DVD player's Y, Pb and Pr jacks and to the Component jacks on the Monitor.
- Connect the audio cable to the DVD player's audio L (White) and R (Red) jacks and to the L and R audio jacks beside the Component jacks on the Monitor.

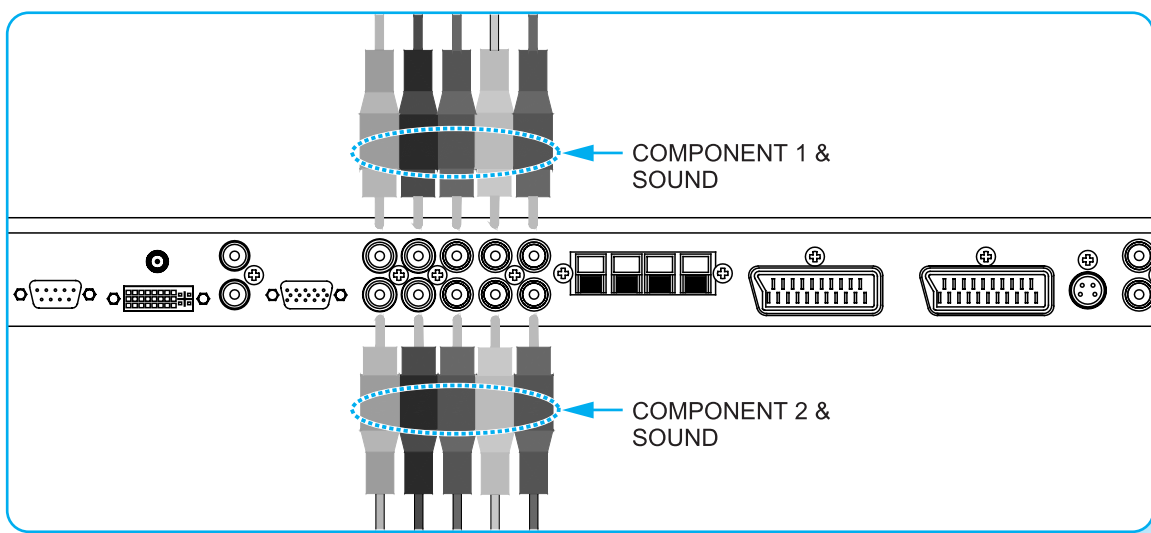

How to use

- 1 Turn on the DVD player.
- 2 Press INPUT button on the remote control of the Monitor and select Component1 or Component2.

Component Input ports

You can get better picture quality if you connect DVD player with component input sockets as below.

Supported Signals for Component ports

	Component1	Component2
480i / 60Hz	✓	✓
480p / 60Hz	✓	✓
576i / 50Hz	✓	✓
576p / 50Hz	✓	✓
720p / 50Hz	✓	✓
720p / 60Hz	✓	✓
1080i / 50Hz	✓	✓
1080i / 60Hz	✓	✓

Component ports of the Monitor	Y	P _B	P _R
Video output ports of DVD player	Y	P _b B-Y	P _r R-Y
	Y	Db P _B	Cr P _R



Notice

- Normal DVD source is based on 480i, which should be through normal YPbPr of Component signal.
- Component, PC, DVI ports can be displayed only 1 signal among them. If one of them is being displayed, other ports are unavailable.

Connecting the Set Top Box

How to connect

Connect Set Top Box video inputs to SCART, COMPONENT, PC or DVI jacks on the Monitor. Audio inputs to Audio sockets beside the L (White) and R (Red) audio jacks which you connect video inputs.

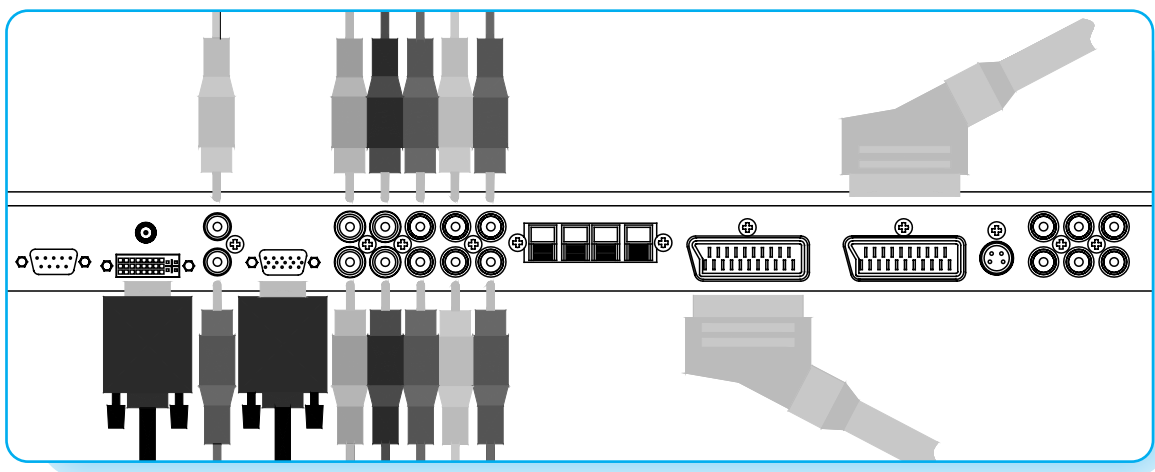

How to use

- 1 Turn on the Set Top Box.
- 2 Press INPUT button on the remote control of the Monitor and select Component1, Component2, PC or DVI.

Supported Signals

	Component1	Component2	PC	DVI
480i/60Hz	✓	✓	✓	✓
480p/60Hz	✓	✓	✓	✓
576i/50Hz	✓	✓	✓	✓
576p/50Hz	✓	✓	✓	✓
720p/50Hz	✓	✓	✓	✓
720p/60Hz	✓	✓	✓	✓
1080i/50Hz	✓	✓	✓	✓
1080i/60Hz	✓	✓	✓	✓

How to connect

With SCART (Euro cable)

Connect a SCART cable to the SCART jacks of the STB and the Monitor.

With Component

Connect a three separate component cables to the component jacks of the STB and the Monitor.
Connect L (White) and R (Red) sound cables (composite) to the sound jacks of the STB and the Monitor.

With RGB or DVI

Connect a D-Sub or DVI cable to the AV video jacks of the STB and the Monitor.
Connect L (White) and R (Red) sound cables (composite) to the sound jacks of the STB and the Monitor.



Notice

- Component, PC and DVI ports can be displayed only 1 signal among them. If one of them is being displayed, other sockets are unavailable.

Connecting the PC[D-Sub & DVI]

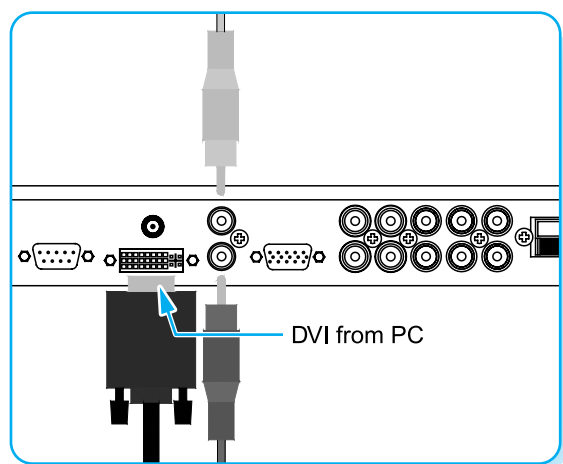
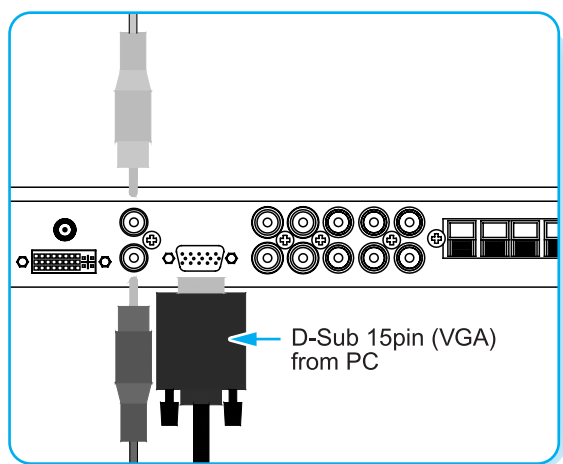

▶ Connecting a PC to the Monitor

Connect a PC (15pin) video cable between the Video Output port on the PC and the PC port on the Monitor.

▶ Pin Configuration

15Pin Signal Cable (based on protruded pin)

▶ Pin Configuration

- ❶ Turn on the Monitor and press INPUT button to select the PC MODE.
- ❷ Turn on the PC and check for the PC requirement.
- ❸ Adjust the PC screen in Geometry menu. (See 43 page.)



Pin No.	Description
1	Red (R)
2	Green (G)
3	Blue (B)
4	Grounding
5	Grounding (DDC)
6	Red (R) Grounding
7	Green (G) Grounding
8	Blue (B) Grounding
9	Reserved
10	Sync Grounding
11	Grounding
12	Data (DDC)
13	Horizontal sync.
14	Vertical sync.
15	Clock (DDC)

Displayable Monitor Specification

Resolution	Horizontal Frequency (KHz)	Vertical Frequency (Hz)
640 x 350	31.468	70.09
	37.861	85.08
640 x 400	31.469	70.08
	37.927	85.03
640 x 480	31.469	59.94
	35.000	66.66
	37.861	72.80
	37.500	75.00
	43.269	85.00
	45.913	90.03
	53.011	100.04
	64.062	120.000
800 x 600	35.156	56.25
	37.879	60.31
	48.077	72.18
	46.875	75.00
	53.674	85.06
	56.000	90.00
	64.016	100.00
832 x 624	49.725	74.55
852 x 480	31.468	60.05
1024 x 768	48.363	60.00
	56.476	70.06
	60.023	75.02
1280 x 768	47.700	60.00
1280 x 1024	64.000	60.00



Notes

- **Synchronization input form : separate**
- The the Monitor recognizes 640x480@60Hz signal as 480p DTV signal. So the signal is expanded, please try other signals like 640x480@75Hz.
- The the Monitor operates abnormally if a non-standard video format is selected.
- 1280 X 768 : 40" Native Resolution Horizontal Polarity is Positive(+) Vertical Polarity is Negative(-)
- Depending on the manufacturer, your PC screen might appear differently (and depending on your particular version of Windows).
Check your PC instruction book for information about connecting your PC to a the monitor.
- The the Monitor may operate abnormally if a non-standard video signal.
- "Out of range" message box will appear when an over-spec video signal is input. Change the video settings of PC when the message is displayed.

Basic Operation

Turning the Monitor On And Off

Press the Power button on the remote control. The the Monitor will turn on and you will be ready to use its features. You can also use the Power key on the front panel.

Select Source

Press INPUT button on the remote control. Then you can see the source list menu shown as below.

Source Change	
1	TV
2	SCART 1
3	SCART 2
4	S-VIDEO /AV
5	COMPONENT 1
6	COMPONENT 2
7	PC
8	DVI

Source list menu

Select the source to watch with PG+ / PG- button on the remote control and press the Menu / Set button.

TV program Selection

- 1 Connect the signal source (TV antenna) to TV input. Press INPUT button on the remote control and select TV on the source list.
- 2 Use PG+, PG- button or numeric button to change TV program you want.
- 3 Press Pre PG button on the remote control to watch the previous program.
- 4 Also, you can tune the cable service, provided programs while using the cable box. For further information regarding cable TV service, contact your TV service provider(s).

Volume Control

Use VOL+ / VOL- button on the remote control to adjust the volume level.
Press MUTE button on the remote control when you need to cut the sound temporarily.

OSD Menu Structure

- OSD (On Screen Display) allows users to control or adjust various features and settings in accordance with his/her preferences.
- Press the Menu/Set button on the remote control to see the main OSD menu.

▶ EXAMPLE of OSD Menu

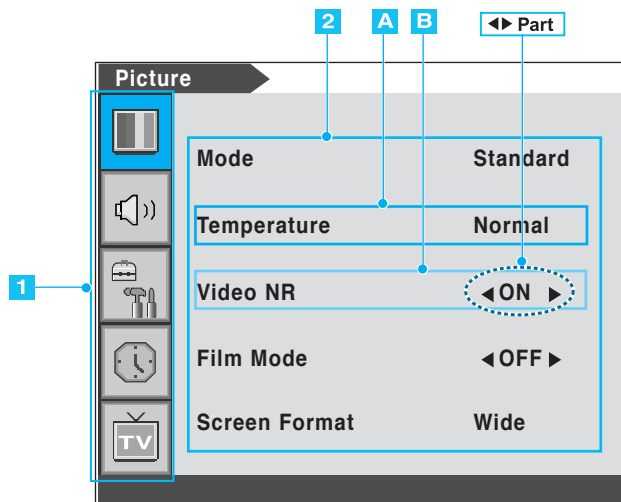

1 Main Menu

Press Menu / Set key on the remote control to enter the main OSD menu. First, select Main menu item you need with PG+ & PG- key. To select a main menu items, just press VOL+ or Menu/Set button on the Remote Control.

2 Sub Menu

Each menu item has its own sub menu items to set.

3 Sub Menu items

- A : If there is no ◀▶ part, the item has an sub menu.
You can enter the sub menu and adjust an item you need.
Select sub-menu item with PG+ / PG- button on the remote control and press VOL+ or Menu/Set button to enter the submenu.
- B : If there is a ◀▶ part, you can set the item by selecting ◀▶. Ex) ◀ ON ▶ or ◀ OFF ▶
Press VOL+ or Menu/Set button to set a ◀▶ part, and adjust it with PG+ / PG- key.

Setting the Channel

Auto Scan

You can now search for and store the TV channels in two different ways : using Auto Scan or Manual Scan.

▶ Auto Scan

- 1 Press Menu/set button to display the main OSD menu.
- 2 Select the TV Main menu.
- 3 Press Menu/Set to enter the sub menu.
- 4 Select **Auto Scan** with PG+/PG- keys and press Menu/Set key on the remote control. Then there will appear the Auto Scan sub menu.
- 5 Select your country. Then the tuning bar will appear. The scanning will start.

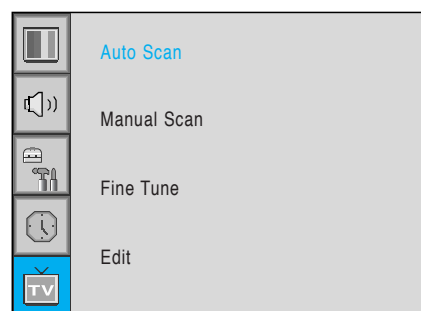

The supported countries are shown as below.

Belgium	Poland
Czech Rep	Sweden
Denmark	Turkey
Germany	Switzerland
England	East Europe
Spain	Others
Finland	
France	
Great Britain	
Greece	
Hungary	
Ireland	
Italy	
Netherlands	
Norway	



Auto Scan for other countries, please refer to the next page.



- You can enter the TV menu in TV mode only. (When you watch a TV program.)

Setting the Channel

▶ Auto Scan (Other Countries)

● Asia

Nation	Selection	Nation	Selection
Malaysia	Others	Israel	Others
Pakistan	Others	Kuwait	Others
Singapore	Others	Arab Emirates	Others
Iran	Others	China	Czech Republic
Saudi Arabia	Others		

● Europe

Nation	Selection	Nation	Selection
Albania	Others	Estonian	Hungary
Andorra	Others	Georgia	Hungary
Croatia	Others	Latvia	Hungary
Iceland	Others	Lithuania	Hungary
Macedonia	Others	Russian Fed.	Hungary
Portugal	Spain	Ukraine	Hungary
Armenia	Hungary	Romania	Poland
Azerbaijan	Hungary	Slovakia	Greece
Belarus	Hungary	Luxembourg	Netherlands
Bulgaria	Hungary	Monaco	France

Setting the Channel

Manual Scan

- 1 Press Menu/set button on the remote control to display the main OSD menu.
- 2 Select the TV main menu with PG+ / PG- button on the remote control.
- 3 Press Menu/Set button to enter the sub menu.
- 4 Select **Manual Scan** with PG+ / PG- button and press Menu/Set button.
- 5 Then you can see the tuning bar. the Monitor will scan from channels to the current channel.

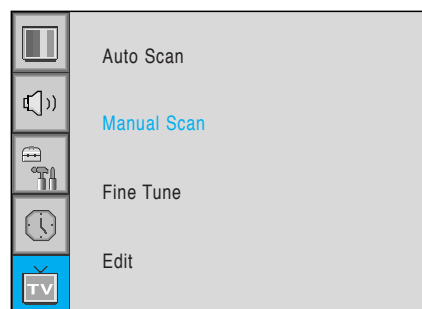

Notes

- Only scanned programs can be stored as Favorite programs.

Fine Tune

The Fine Tuning function lets you manually adjust the Monitor's tuner if you have difficulty tuning analog Channels.

- 1 Press Menu/set button to display the main OSD menu.
- 2 Select the TV main menu.
- 3 Press Menu/Set to enter the Fine tune sub menu.
- 4 Select **Fine Tune** with PG+ / PG- button and press Menu/Set button. Then you can see the adjust bar.
- 5 Adjust the fine tune with VOL+ or VOL- button.

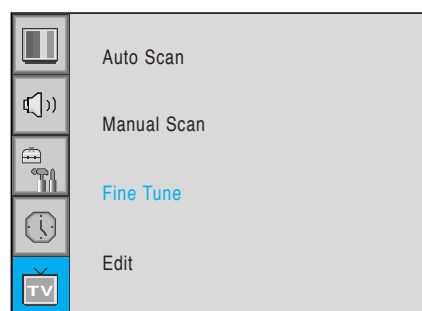

Setting the Channel

Edit

▶ Edit Favorite program List

You can store of your favorite channels for each available input source (such as TV or CATV). Then, when you press the FAVORITE button on the remote control, the Monitor display only the favorite channels you previously stored, allowing you to quickly and easily find frequently wanted channels.

- 1 Press Menu/set button to display the main OSD menu.
- 2 Select the TV main menu.
- 3 Press Menu/Set to enter the TV sub menu.
- 4 Select **Edit** and press the Menu/Set button. Then you can see the Favorite program List.
- 5 You can select a program with PG+ / Pg button on the remote control.

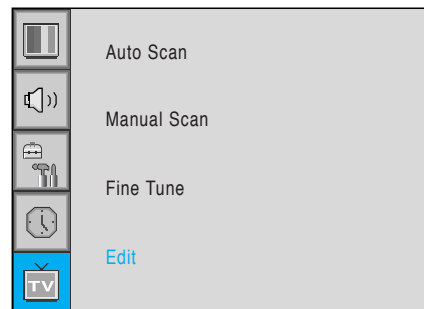

Pr gg	Name Kljwef	CH 69	Picture SECAM	Sound D/K	Skip No	FAV Yes
1	KGBMS	21	AUTO	AUTO	Yes	Yes
2	KGBMS	21	AUTO	AUTO	Yes	Yes
3	KGBMS	21	AUTO	AUTO	Yes	Yes
4	KGBMS	21	AUTO	AUTO	Yes	Yes
5	KGBMS	21	AUTO	AUTO	Yes	Yes
6	KGBMS	21	AUTO	AUTO	Yes	Yes
7	KGBMS	21	AUTO	AUTO	Yes	Yes

◀ ▶ Move

▶ TO EDIT THE LIST

You can INSERT, ERASE, SKIP and REPLACE the programs in the list. Refer to the picture of the remote control below.

▶ TO EDIT THE PROGRAM IN THE LIST

If you want to edit a program, press Menu/Set button. Then you can select a field with VOL+/VOL- button. Press Menu/Set button on the field to edit. Adjust the field with PG+/PG- button. To return, press BACK button.

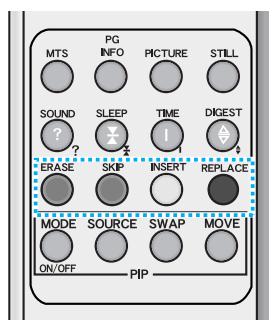

- 1 **ERASE**
Erase the selected program from the list.
- 2 **SKIP**
Make the selected program will be skipped.
- 4 **INSERT**
Insert new list item.
- 5 **REPLACE**
Replace the selected program with the Current programs that you're watching.



- Only scanned channels can be set as Favorite Channels.

Digest Function

▶ Digest

In the Digest function, you can watch 15 programs at the same time. (This function works only in TV mode)

- 1 Press the Digest button on the Remote Control.
- 2 By pressing the channel number, the selected channel becomes main window.
- 3 You can make off the Digest Function by pressing Digest button again.

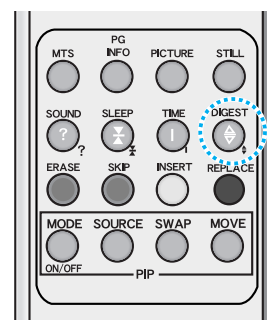

Teletext On / Mix / Off

You can switch on and off teletext function by pressing TEXT button on remote control.

TOP text

The user guide displays four fields - red, green, yellow and blue - at the bottom of the screen. The yellow field denotes the next group and the blue field denotes next block.

Block / Group / Page Selection

- With the blue button you can move block to block
- Use the yellow button to proceed to the next group with automatic overflow to the next group.
- With the green button, you can go to the next exiting page. (Use PG+ button as alternate).
- With the red button, you can go to the previous page.(Use PG- button as alternate)

You can go to the page by pressing the NUMBER button on the remote control.

FASTEXT

The teletext pages are color coded along the bottom of the screen and are selected by pressing the corresponding colored button. Press index key to select the index page. You can go to a page by pressing the NUMBER button on remote control. You can move a page by pressing PG+ or PG- button to select the page you want to see.

Setting the Picture

Mode

Your the Monitor has 3 automatic factory preset picture settings ("Standard", "Vivid" and "Mild"). You can choose Standard, Vivid or Mild by pressing "Picture" key on the remote control (or by making a selection from the menu). Or you can select User which automatically recalls your personalized picture settings.

- 1 Press Menu/set button to display the main OSD menu.
- 2 Select the picture main menu.
- 3 Press Menu/Set to enter the sub menu.
- 4 Select **Mode** and press Menu/Set to enter the sub menu. Then the picture sub mode appear.
- 5 Select the picture mode and press Menu/Set button.
- 6 You will see the picture setting bars. Just Press BACK button on the remote control. You can adjust each values of the picture setting, but the changed values are stored as in User mode.

USER mode has additional settings in a sub-menu: See next page.

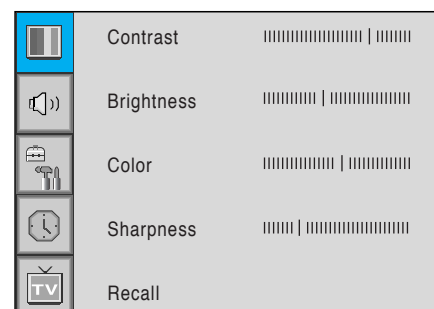
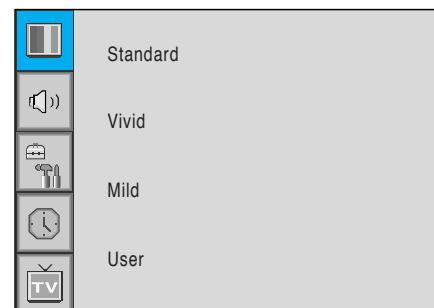
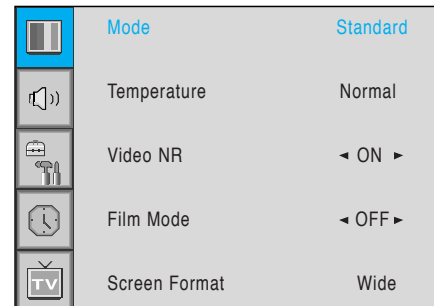

Notes

- **Alternative method** : Just press the "Picture" button on the remote control. Each time it is pressed, different mode is selected.

Setting the Picture

▶ Adjust User Mode

You can change the Contrast, Brightness, Color, and Sharpness according to personal preference in User mode.

- 1 Select the item to adjust with PG-, PG+ button.
- 2 Press Menu/Set button.
- 3 Adjust the item with VOL-, VOL+ button.
- 4 To cancel all adjust, select **Recall** and press Menu/Set button.

For a more detailed description of these settings, see the next page."

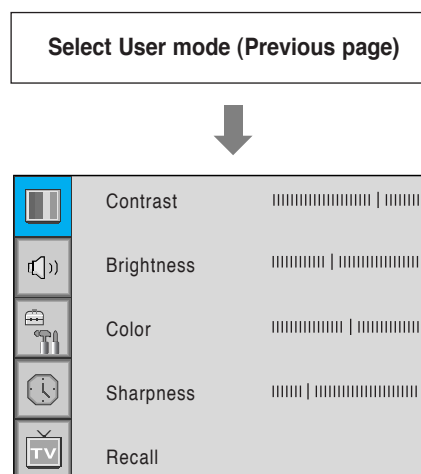

Setting the Picture

▶ CONTRAST

Adjust brightness difference between bright part of the screen and dark part.

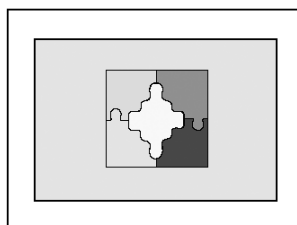

Distinct ◀

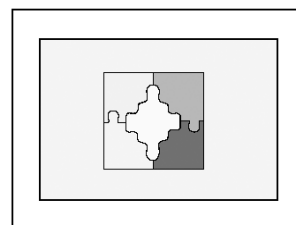

▶ Vague

▶ BRIGHTNESS

Adjust brightness of the screen.

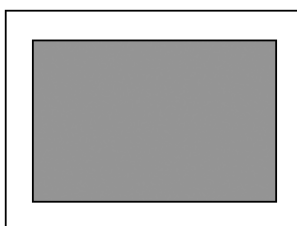

Dark ◀

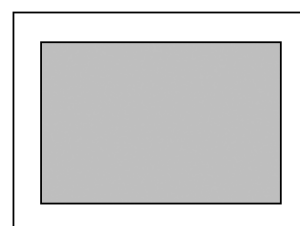

▶ Bright

▶ COLOR

Adjust deep and light color of the screen.



Decrease ◀



▶ Increase

▶ SHARPNESS

Adjust vividness of the screen.

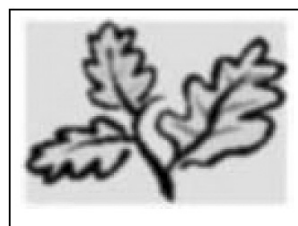

Less sharp ◀

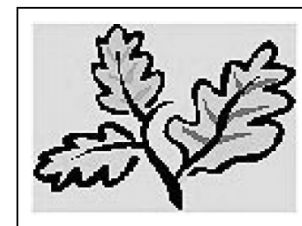

▶ Sharp

Setting the Picture

Temperature

Your the Monitor has 5 screen temperatures (color settings):

- 1 Press Menu/set button to display the main OSD menu.
- 2 Select the picture main menu.
- 3 Press Menu/Set to enter the picture menu.
- 4 Select **Temperature** and press Menu/Set to enter the sub menu.
Then the Picture-Temperature sub menu appear.
- 5 Select the Temperature mode with PG- / PG+ button and press Menu/Set button.
- 6 Press BACK button to return.

► Cool 1, 2

Screen seems cool: Strong Blue

► Normal

Normal: Factory default.

► Warm 1, 2

Screen seems warm: Strong Red

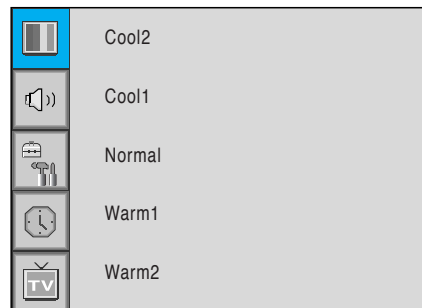
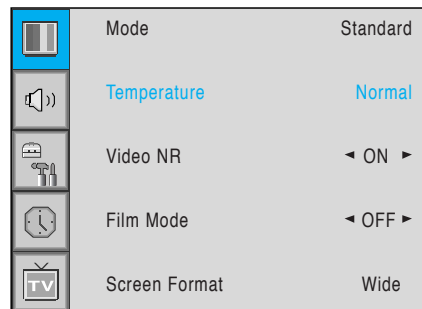





Setting the Picture





Video NR

This function automatically filters out and reduces the image noise and improves picture quality when receiving weak signals.

- 1 Press Menu/Set button to display the main OSD menu.
- 2 Select the picture main menu item.
- 3 Press Menu/Set to enter the sub menu.
- 4 Select **Video NR** and press VOL+ button to enter the ◀▶ parts. Then the cursor moves into the ▶▶ parts.
- 5 Turn on or off Video NR function with PG+/PG- button and press BACK button.

	Mode	Standard
	Temperature	Normal
	Video NR	◀ OFF ▶
	Film Mode	OFF
	Screen Format	Wide







	Mode	Standard
	Temperature	Normal
	Video NR	◀ ON ▶
	Film Mode	OFF
	Screen Format	Wide





Screen Format

Your the Monitor has four Screen Formats: Wide, PANORAMA, ZOOM1, ZOOM2, 4:3.
(For more detail description for these modes, refer to the next page.)

- 1 Press Menu/Set button to display the main OSD menu.
- 2 Select the picture main menu.
- 3 Press Menu/Set to enter the picture menu.
- 4 Select **Screen Format** and press Menu/Set to enter the sub menu. Then the Screen Format sub menu appear.
- 5 Select the Screen Format you want and press Menu/Set button

	Mode	Standard
	Temperature	Normal
	Video NR	◀ ON ▶
	Film Mode	OFF
	Screen Format	Wide



	Wide
	Panorama
	Zoom1
	Zoom2
	4 : 3

Setting the Picture

► Screen Format Description

Wide

Wide video: No change.

4:3 video: Expands 4:3 video signal horizontally to fit the Wide screen.

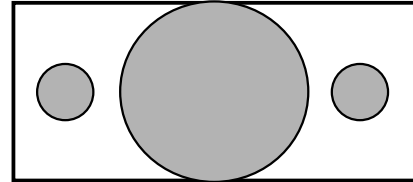

Panorama

Wide video: No change.

4:3 video: Expands 4:3 video horizontally to fit the Wide screen and to minimize distortion, sides are expanded more than center.

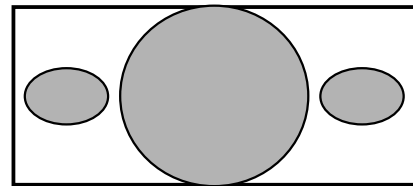

Zoom 1

Expands Wide mode screen vertically.

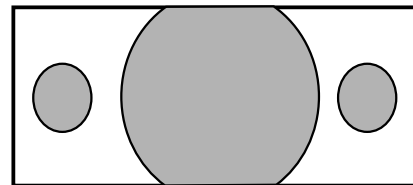

Zoom 2

Expands zoom 1 mode screen vertically.

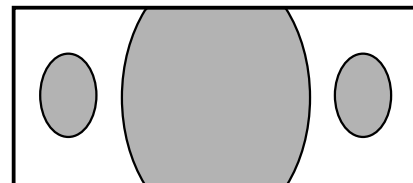

4:3

Wide video: The image is suppressed.

4:3 video: No expansion. There are gray areas besides the image.

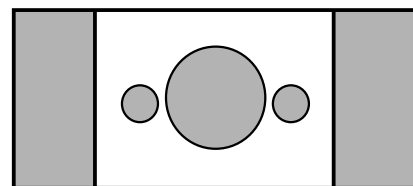

Setting the Picture [PC]

In PC mode, you can adjust the H, V-Position, Native Mode and Phase. Also you can adjust them automatically.

Geometry

You can change H, V-Position, Native Mode in PC mode like usual PC monitors.
You can also adjust them automatically. (Auto adjust function.)

- 1 Press Menu/set button to display the main OSD menu.
- 2 Select the picture main menu with PG+, PG- button.
- 3 Press Menu/Set to enter the sub menu.
- 4 Select **Geometry** and press Menu/Set to enter the sub menu. Then the picture Geometry sub menu will appear.

- 1 Select the item to adjust with PG-, PG+ button.
- 2 Press Menu/Set button.
- 3 Then the cursor moves on the bar and you can adjust the value with VOL-, VOL+ button.
- 4 To adjust these items, automatically, select **Auto Adjust** and press Menu/Set button.

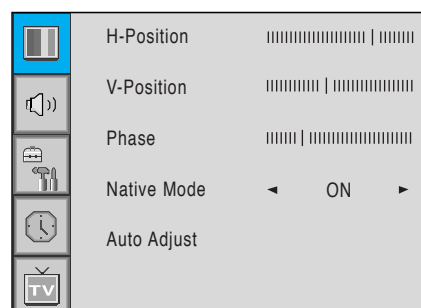
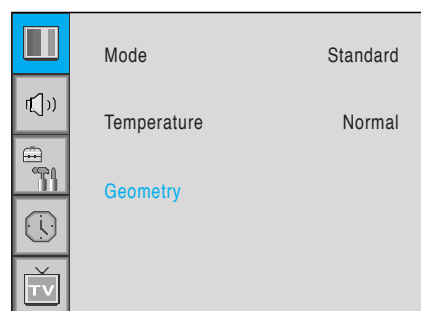

For more detail description refer to the next page.

Setting the Picture [PC]

▶ H-POSITION

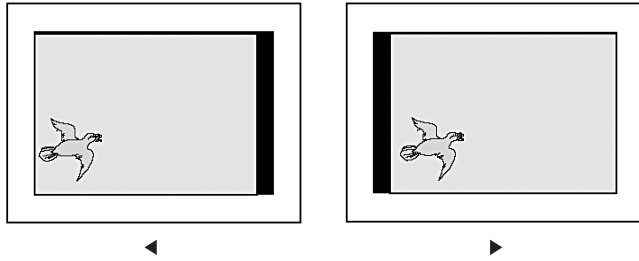

▶ V-POSITION

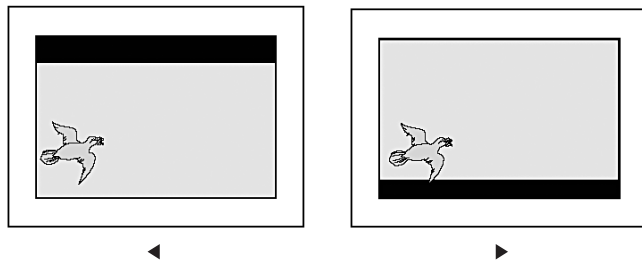

▶ PHASE

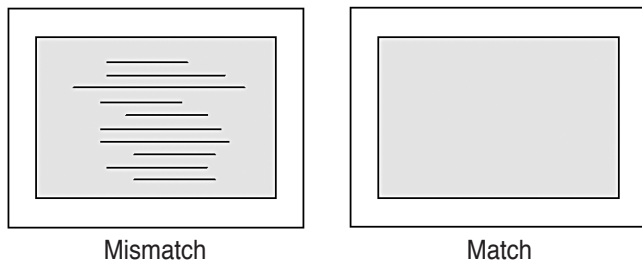

Setting the Sound

In SOUND Menu, you can adjust balance, MTS (Multi-Track Sound), AVC (Auto Volume Control) and select the equalizer settings.

Balance

This control allows you to adjust the balance of the left and right speaker output.

- 1 Press Menu/set button to display the main OSD menu.
- 2 Select the SOUND main menu.
- 3 Press Menu/Set to enter the sub menu.
- 4 Select **Balance** and press Menu/Set button.
- 5 Adjust the Balance with VOL-, VOL+ button and press Menu/Set button.

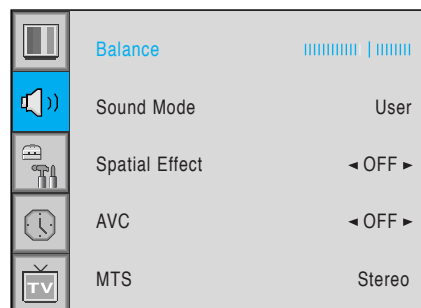

Sound Mode

Your the Monitor has four automatic sound settings ("Standard", "Movie", "Music" and "News") that are preset at the factory. You can activate either Standard, Movie, Music or News by pressing "SOUND" on the remote control (or by making a selection from the menu) or you can select "Custom" which automatically recalls your personalized sound settings.

- 1 Press Menu/set button to display the main OSD menu.
- 2 Select the SOUND main menu.
- 3 Press Menu/Set button to enter the sub menu.
- 4 Select **Sound Mode** and press Menu/Set Button to enter the sub menu. Then the Mode sub menu appear.
- 5 Select the **Equalizer** setting and press Menu/Set button.
- 6 You will see the Equalizer bars. Just press BACK button on the remote control. You can adjust each values of Equalizer, but the changed values are stored as in User mode.

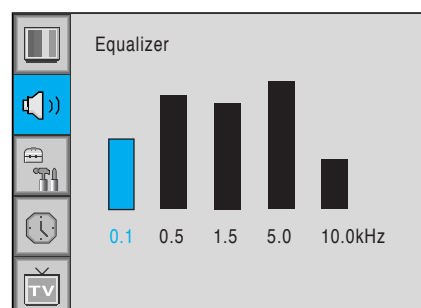
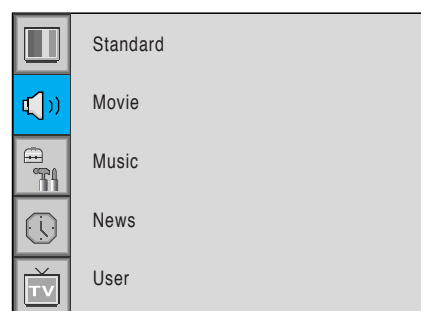
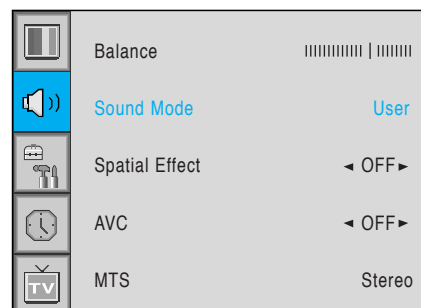

User mode require more settings.
It has sub menu: See next page.

Setting the Sound

User Adjust

You can use the OSD menu to change the Treble, Bass, Balance and DRC according to your preference.

- 1 Equalizer menu appear when you select User mode.
- 2 Select a gain bar with VOL+, VOL button on the remote control and adjust it with PG+ / PG- button.
- 3 Press BACK or BACK button on the remote control to exit Equalizer. The result will be saved automatically.

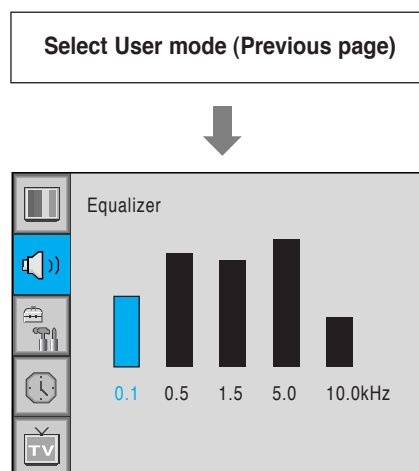

Spatial Effect

This function can create surround effect such as the sound seems to come from all directions.

- 1 Press Menu/set button to display the main OSD menu.
- 2 Select the SOUND main menu item with PG+/PG- button.
- 3 Press Menu/Set to enter the sub menu.
- 4 Select **Spatial Effect** and press VOL+ button.
- 5 Turn on or off Spatial Effect function with PG+/PG- button and press Menu/Set button.

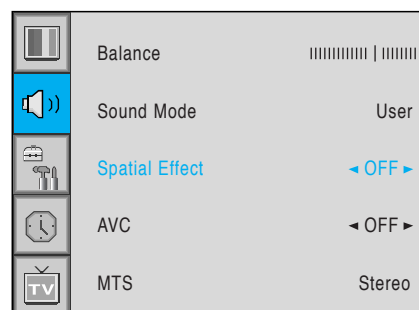

AVC (Auto Volume Control)

This function adjust sound volume level automatically depending on the source.

- 1 Press Menu/set button to display the main OSD menu.
- 2 Select the SOUND main menu.
- 3 Press Menu/Set to enter the sub menu.
- 4 Select **AVC** and press VOL+ button to enter the ◀▶ parts. Then the cursor moves into the ◀▶ parts.
- 5 Turn on or off AVC function with PG+/PG button and press BACK button.

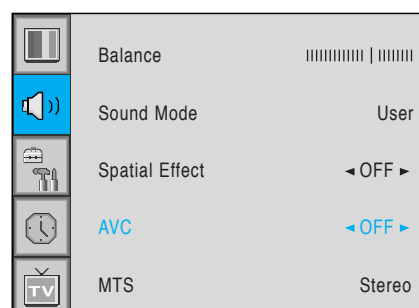

Setting the Sound

MTS

► Multichannel Telesion Sound

Select sound signal format from the input source. There are Mono, Stereo, Language A, Language B, Language AB sound formats.

- 1 Press Menu/set button to display the main OSD menu.
- 2 Select the SOUND main menu with PG+ / PG- button on the remote control.
- 3 Press Menu/Set to enter the sub menu.
- 4 Select **MTS** and press Menu/Set to enter the sub menu. Then the MTS sub menu appear.
- 5 Select the MTS format with PG+ / PG- and press Menu/Set button.

The available sound formats are displayed.
Usually, you can see Mono and Stereo.

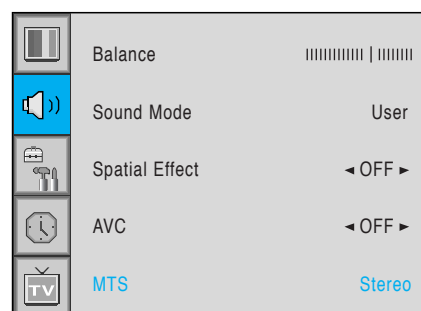

Notes

- **NICAM** : A Digital stereo sound format for analog TV from BBC. If a channel transmit NICAM sound signal, you can hear high quality digital stereo sound.
The the Monitor recognize NICAM automatically.

Setting the Others

In SET UP menu, you can adjust the transparency of the OSD menu and set PIP and others.

Translucent

Adjust the transparency of the OSD menu. There are 8 step from OFF to 7.

- 1 Press Menu/set button to display the main OSD menu.
- 2 Select the SET UP main menu with PG+ / PG- button on the remote control.
- 3 Press Menu/Set button to enter the sub menu.
- 4 Select **Translucent** and press VOL+ button to enter the ◀▶ parts. Then the cursor moves into the ◀▶ parts.
- 5 Adjust with PG+ & PG- button and press EXIT button.

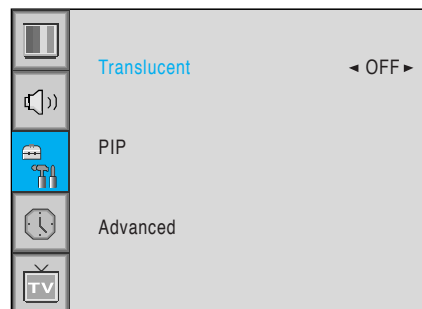

PIP (Picture In Picture)

You can watch two programs or sources at the same time. And set up PIP size and position.

- 1 Press Menu/set button to display the main OSD menu.
- 2 Select the SET UP main menu with PG+ / PG- button on the remote control.
- 3 Press Menu/Set button to enter the sub menu.
- 4 Select **PIP** and press Menu/Set button to enter the sub menu. Then the PIP sub menu appear.



PIP Window

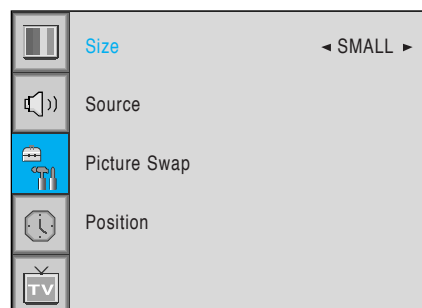
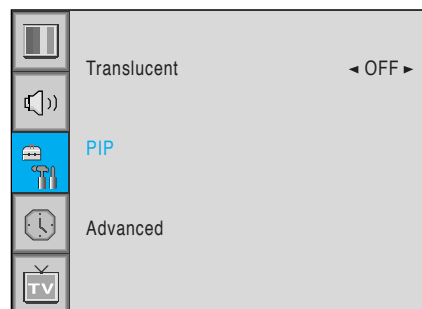

Setting the Others

▶ Size in PIP (Picture In Picture)

Change the size of the PIP window. There are 3 sizes: SMALL, Large, Twin.

- 1 Select **Size** and press VOL+ button to enter the ◀▶ parts. Then the cursor moves into the parts.
- 2 Adjust size function with PG+ & PG- button and press Menu/Set button.



SMALL



LARGE

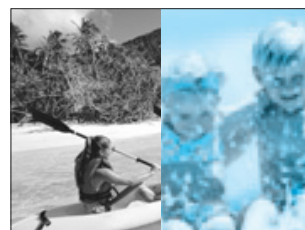

TWIN

▶ Source in PIP

Change the source of the PIP window.

- 1 Select **Source** and press Menu/Set to enter the sub menu. Then the PIP sub menu appear.
- 2 The available sources will be displayed. Select the source and press Menu/Set button.

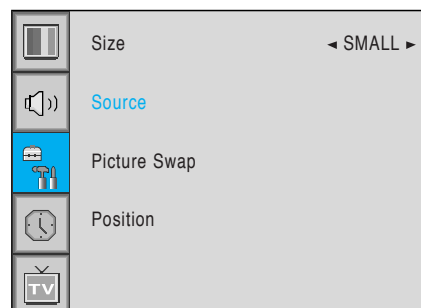

This picture is an example.
The displayed sources may be
different depending on the
main input source.

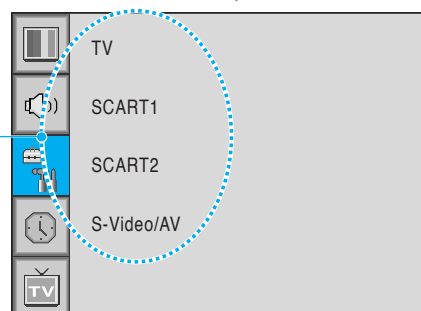

Setting the Others

PIP \ Main	TV	SCART1	SCART2	S-Video/AV	Component1	Component2	PC	DVI
TV	✓	✓	✓	✓	✓	✓	✓	✓
SCART	✓	✓	✓	✓	✓	✓	✓	✓
SCART 2	✓	✓	✓	✓	✓	✓	✓	✓
S-Video	✓	✓	✓	✓	✓	✓	✓	✓
Component1	✓	✓	✓	✓	✓	✓	✓	✓
Component2	✓	✓	✓	✓	✓	✓	✓	✓
PC	✓	✓	✓	✓	✓	✓	✓	✓
DVI	✓	✓	✓	✓	✓	✓	✓	✓

▶ Picture Swap in PIP (Picture In Picture)

Swap the sources of the main screen and the PIP window.

Select Picture Swap and press Menu/Set button.

▶ Position in PIP

Change the position of the PIP window.

- 1 Select **Position** with PG+ / PG- button on the remote control and press Menu/Set to enter the sub menu. Then the PIP sub menu appear.
- 2 In Sub Menu, there are four positions. Select the position with PG+ / PG- button on the remote control and press BACK button

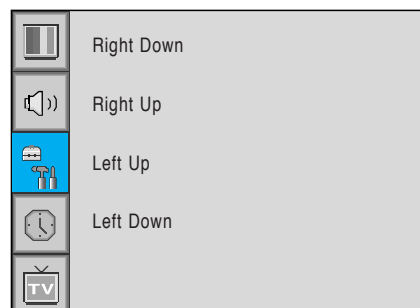
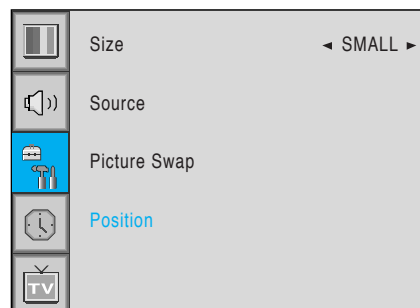

Setting the Others

Advanced

You can set up ID, Blue Back, Language and Front key Lock in Advanced Menu.

- 1 Press Menu/set button to display the main OSD menu.
- 2 Select the SET UP main menu with PG+ / PG- button on the remote control.
- 3 Press Menu/Set to enter the sub menu.
- 4 Select **Advanced** and press Menu/Set to enter the Advanced menu. Then the PIP sub menu appear.

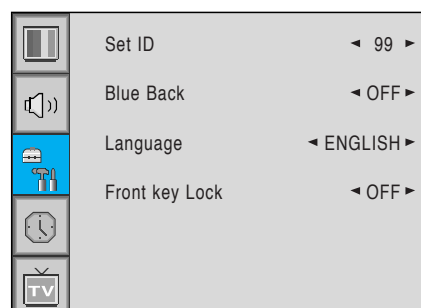
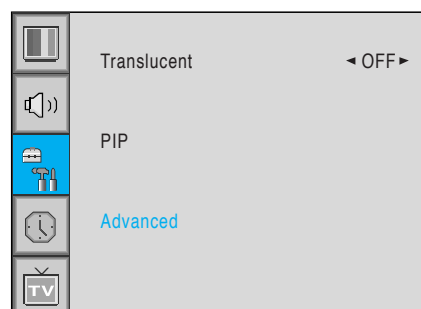

▶ Set ID in Advanced

Set the ID of the Monitor for mass-controlling through the serial port.

- 1 Select **Set ID** and press VOL+ button to enter the ◀▶ part. Then the cursor moves into the ◀▶ part.
- 2 Adjust with PG+ / PG- button and press BACK button.

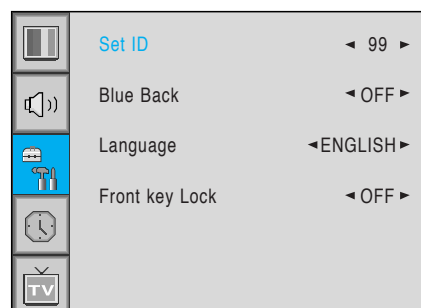

Setting the Others

▶ Blue Back in Advanced

You can set to display blue-color screen instead of noise screen.

- 1 Select **Blue Back** and press VOL+ button to enter the ◀▶ parts. Then the cursor moves into the ◀▶ parts.
- 2 Turn the function on or off with PG+ / PG- button and press BACK button.

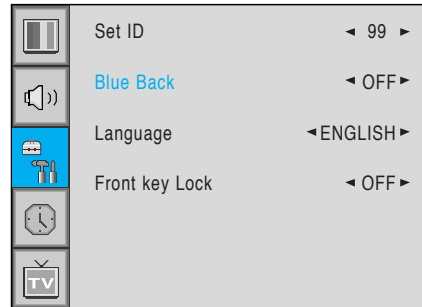

▶ Language in Advanced

Set the language to use in OSD.

Supported languages are English, French, German, Spanish, Italian, Chinese, Russian.

- 1 Select **Language** and press VOL+ button to enter the ◀▶ parts. Then the cursor moves into the ◀▶ parts.
- 2 Choose the Language with PG+ / PG- button and press BACK button.

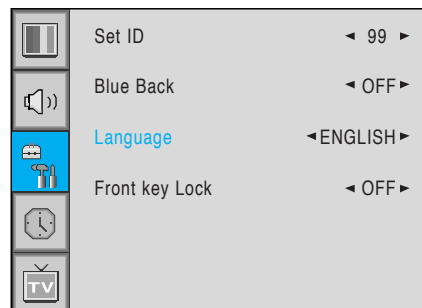

▶ Front key Lock in Advanced

Lock the OSD panel of the Monitor. It can protect the Monitor from children's power on/off or other operation by miss.

- 1 Select **Front key Lock** and press VOL+ button to enter the ◀▶ parts. Then the cursor moves into the ◀▶ parts.
- 2 Turn the function on or off with PG+ / PG- button and press BACK button

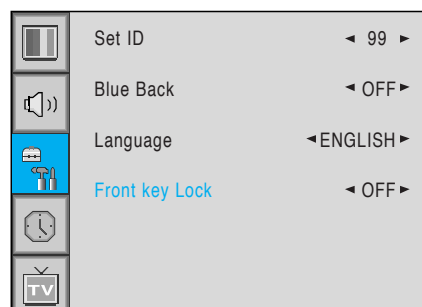







Setting the Time

In the TIME menu, you can set the current time and auto power on / off.

Time Set

Set the current time.







- 1 Press Menu/set button to display the main OSD menu.
- 2 Select the TIME main menu.
- 3 Press Menu/Set to enter the sub menu.
- 4 Select **Time Set** by pressing VOL+ button.
- 5 Move the cursor by pressing VOL-, VOL+ button and adjust time by PG+, PG- button.

	Time set	AM 03:29
	On Time	AM 05:11 ON
	On Channel	◀ 99 ▶
	On Volume	◀ 100 ▶
	Off Time	AM 05:11 OFF
	Sleep	◀ OFF ▶

On Time

This the Monitor can be set to turn on automatically at specific time that you choose. Before using the timer, you must set the Monitor's Time as described previously.

- 1 Press Menu/set button to display the main OSD menu.
- 2 Select the TIME main menu with PG+ / PG- button on the remote control.
- 3 Press Menu/Set to enter the sub menu.
- 4 Select **On Time** with PG+ / PG- button and press VOL+ button.
- 5 Move the cursor by VOL-, VOL+ button and adjust time by PG+, PG- button.

	Time set	AM 03:29
	On Time	AM 05:11 ON
	On Channel	◀ 99 ▶
	On Volume	◀ 100 ▶
	Off Time	AM 05:11 OFF
	Sleep	◀ OFF ▶

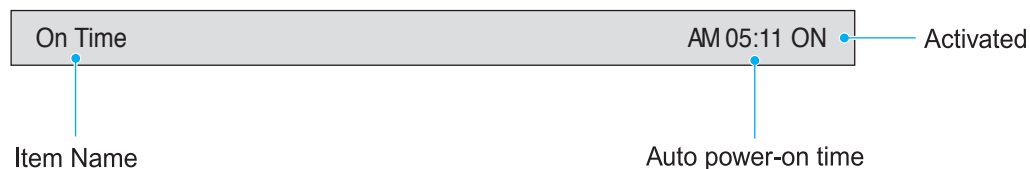







Setting the Time

On Channel

Set the channel when the Monitor power turn on automatically.

Available only when the Time is set and On Time is ON.

- 1 Press Menu/set button to display the main OSD menu.
- 2 Select the TIME main menu with PG+ / PG button on the remote control.
- 3 Press Menu/Set to enter the sub menu.
- 4 Select **On Channel**.
- 5 Enter to the ◀▶ part with VOL+ button. Then the cursor moves into the ◀▶ parts.
- 6 Adjust the channel with PG+ / PG- button. Press BACK button to return.







	Time set	AM 03:29
	On Time	AM 05:11 ON
	On Channel	◀ 99 ▶
	On Volume	◀ 100 ▶
	Off Time	AM 05:11 OFF
	Sleep	◀ OFF ▶

On Volume

Set the sound volume level when the Monitor power on automatically.

Available only when the Time is set and On Time is ON.

- 1 Press Menu/set button to display the main OSD menu.
- 2 Select the TIME main menu with PG+ / PG button on the remote control.
- 3 Press Menu/Set to enter the sub menu.
- 4 Select **On Volume**.
- 5 Enter to the ◀▶ part by pressing VOL+ button. Then the cursor moves into the ◀▶ parts.
- 6 Adjust the sound volume level with PG+ / PG button.

	Time set	AM 03:29
	On Time	AM 05:11 ON
	On Channel	◀ 99 ▶
	On Volume	◀ 100 ▶
	Off Time	AM 05:11 OFF
	Sleep	◀ OFF ▶

Setting the Time

Off Time

This the Monitor can be set to turn off automatically at specific times that you choose. Before using the timer, you must set the Monitor's clock as described previously.

- 1 Press Menu/set button to display the main OSD menu.
- 2 Select the TIME main menu with PG+ / PG- button on the remote control.
- 3 Press Menu/Set to enter the sub menu.
- 4 Select **Off Time** with PG+ / PG- button on the remote control and press VOL+ button.
- 5 Move the cursor with VOL- / VOL+ button and adjust time with PG+ / PG- button.

	Time set	AM 03:29
	On Time	AM 05:11 ON
	On Channel	< 99 >
	On Volume	< 100 >
	Off Time	AM 05:11 OFF
	Sleep	< OFF >

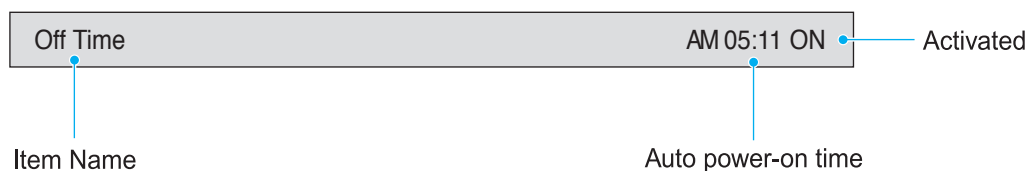

Sleep

You can set your the Monitor to automatically turn off after a preset interval.

If you turn off the Monitor in the state of setting up sleep time and turn on again, sleep time erased therefore set up again. The time period runs from OFF(0min) to 180min. (OFF, 10min, 20, 30, 60, 90, 120, 150, 180)

- 1 Press Menu/set button to display the main OSD menu.
- 2 Select the TIME main menu. with PG+ / PG- button on the remote control.
- 3 Press Menu/Set to enter the sub menu.
- 4 Select **Sleep** with PG+ / PG- button on the remote control and press VOL+ button.
- 5 Enter to the ◀▶ part with VOL+ button. Then the cursor moves into the ◀▶ parts.
- 6 Set the time period with PG+ / PG- button.
- 7 Press BACK button to return.

	Time set	AM 03:29
	On Time	AM 05:11 ON
	On Channel	< 99 >
	On Volume	< 100 >
	Off Time	AM 05:11 OFF
	Sleep	< OFF >

Troubleshooting

If your monitor is not working properly, please scan this list of problems and possible solutions. It may save you time and money.

Problem	Quick Action for Possible Solution
No picture & No sound	<ul style="list-style-type: none">• Check whether the Monitor is turned on.• Power cord inserted into wall outlet?• Plug another product's power cord into the wall outlet where the Monitor's power cord was plugged in.
Picture OK & No sound	<ul style="list-style-type: none">• Press the VOLUME(▶) button.• Check the audio input signal.
The remote control doesn't work	<ul style="list-style-type: none">• Check to see if there is any object between the Monitor and the remote control causing obstruction.• Check to see if the batteries are installed with the correct polarities.
Digital broadcasting screen problem	<ul style="list-style-type: none">• Check the digital signal strength and input antenna.
No or Poor color or Poor picture	<ul style="list-style-type: none">• Select Color in the Picture and press VOLUME (▶) button.• Keep a certain distance between the Monitor and the input source.• Activate any function to restore the brightness of the picture.• Check to see that both the monitor and the source are plugged in and turned on.
The image is too light or too dark	<ul style="list-style-type: none">• Adjust the Brightness or Contrast settings.
The image is too large or too small	<ul style="list-style-type: none">• Adjust the Size settings.
No output from one of the speakers	<ul style="list-style-type: none">• Adjust Balance in the Sound Menu.

Warranty Card

Limited Warranty

Subject to the Limitations, Exclusions and Disclaimers hereof, InFocus Corporation ("InFocus") warrants that the LCD Thin Display Device and Accessories (hereinafter collectively or individually referred to as "Product" as appropriate) purchased from InFocus, an InFocus distributor, or an InFocus reseller will conform to InFocus' specifications and be free from defects in material or workmanship for the respective Limited Warranty period provided below. InFocus does not warrant that the Product will meet the specific requirements of the end-user customer. If the Product while subject to this Limited Warranty, is defective in material or workmanship during the warranty period, then InFocus, at its option, will REPAIR or REPLACE the Product. All exchanged parts and Products replaced under this Limited Warranty will become property of InFocus. InFocus' sole obligation is to supply (or pay for) all labor necessary to repair the Product found to be defective within the Limited Warranty period and to repair or replace defective parts with new parts or, at the option of InFocus, serviceable used parts that are equivalent or superior to new parts performance. Limited Warranty periods are as follows:

Product Limited Warranty Period: one (1) year from date of purchase.

Accessory Product Limited Warranty Period: one (1) year from date of purchase.

WARRANTY LIMITATION AND EXCLUSION

THIS WARRANTY SETS FORTH INFOCUS' MAXIMUM LIABILITY FOR ITS PRODUCT. THIS WARRANTY EXTENDS ONLY TO PRODUCTS PURCHASED FROM INFOCUS OR AN INFOCUS AUTHORIZED RESELLER. . InFocus shall have no further obligation under the foregoing Limited Warranty if the Product has been damaged due to abuse, improper ventilation, fire, water, disaster, mispackaging, shipping, lightning or other acts of nature, misuse, neglect, smoke exposure (cigarette or otherwise), accident, unusual physical or electrical stress and/or power surges, unauthorized modifications (including use of an unauthorized mount), tampering, alterations, service other than by InFocus or its authorized service providers, or failure caused other than from ordinary use or failure to properly use the Product in the application for which said Product was intended. In addition, failure of the end-user to follow maintenance procedures as outlined in the product's user guide, where a schedule is specified for regular cleaning of certain parts (based on usage and environment), and the end-user has failed to follow such schedule, the Product will not be covered under the Limited Warranty. Finally, InFocus shall have no further obligation if InFocus Product was subjected to operating conditions outside of the range specified in the user's guide or in this Limited Warranty. This Limited Warranty excludes Product cleaning, repair, or replacement of plastics and glass due to cosmetic damage and damage as a result of normal wear. Product repair outside of the terms of the Limited Warranty will be on a time and materials basis. Prolonged Product "demonstration" causes unusual Product wear and is not considered normal use under the terms of this Limited Warranty. Wide screen format displays (16:9, the aspect ratio of the screen width to height) are primarily designed to view wide screen format full-motion video. The images displayed on them should primarily be in the wide screen 16:9 ratio format, or expanded to fill the screen if your model offers this feature, and constantly moving. Displaying stationary graphics and images on screen, such as the dark side-bars on non-expanded standard 4:3 ratio format video, should be limited to no more than 15% of the total viewing time. LCD burn-in as a result of excessive display of static images is not covered under the terms of this Limited Warranty. The Accessory Product Limited Warranty covers the accessory item only and excludes normal wear. Remanufactured Products and Software Products are exempt from the foregoing Limited Warranty. Please refer to the appropriate Remanufactured Product Limited Warranty or Software Product Limited Warranty for applicable Warranty information.

DISCLAIMER OF UNSTATED WARRANTIES

THE WARRANTY PRINTED ABOVE IS THE ONLY WARRANTY APPLICABLE TO THIS PRODUCT. ALL OTHER WARRANTIES, EXPRESS OR IMPLIED, INCLUDING, BUT NOT LIMITED TO, THE IMPLIED WARRANTIES OF MERCHANTABILITY AND FITNESS FOR PARTICULAR PURPOSE ARE DISCLAIMED. THERE ARE NO WARRANTIES THAT EXTEND BEYOND THE DESCRIPTION ON THE FACE HEREOF AND THE FOREGOING WARRANTY SHALL NOT BE EXTENDED, ALTERED OR VARIED EXCEPT BY WRITTEN INSTRUMENT SIGNED BY INFOCUS. SOME JURISDICTIONS DO NOT ALLOW LIMITATIONS ON HOW LONG AN IMPLIED WARRANTY MAY LAST, SO SUCH LIMITATIONS MAY NOT APPLY TO YOU.

Warranty Card

Limited Warranty Period

The Limited Warranty periods hereof commence on the date of purchase by the end-user customer. These Limited Warranty provisions shall apply only to the end-user purchaser (first person or entity that purchased a new Product for personal or business use and not for the purpose of distribution or resale). SOME JURISDICTIONS MAY GRANT YOU CONSUMER RIGHTS WITH MINIMUM WARRANTY DURATION THAT DIFFER FROM THE DURATIONS PROVIDED HEREIN, AND INFOCUS WILL HONOR ALL SUCH CONSUMER RIGHTS.

To Be Eligible For Limited Warranty Coverage

Any person exercising a claim under this Limited Warranty must establish to the satisfaction of InFocus both the date of purchase and that the Product was purchased new from InFocus or an InFocus authorized reseller. The sales receipt or invoice, showing the date of purchase of the Product is the proof of the date of purchase.

To Obtain Warranty Service

During the Limited Warranty period, to exercise this Limited Warranty, the purchaser must first contact 1) InFocus, 2) a service facility authorized by InFocus or 3) the place of original purchase. InFocus Customer Service - 1-503-685-8888 or visit www.infocus.com/service

For Warranty service, the purchaser will be advised to return or deliver the defective Product freight and all fees prepaid, to an InFocus Service Center or to a service facility authorized by InFocus. When returning Product to InFocus, a Return Materials Authorization (RMA) # is required and must be clearly displayed on the outside of the shipping carton or a similar package affording an equal degree of protection. InFocus or the service facility authorized by InFocus will return the repaired/replaced Product freight prepaid to the purchaser.

Products returned for Warranty service must be accompanied by a written letter that: (i) explains the problem; (ii) provides proof of date of purchase; (iii) provides the authorized reseller's name; and (iv) provides the model and serial number of the Product. Upon request of InFocus Corporation or a service facility authorized by InFocus, proof of legal import must accompany the warranty repair Product, otherwise the Product must be returned to the place of original purchase, to the manufacturer (Purchaser must bear all tax, duty and freight), or the Purchaser must bear charges for the warranty repair.

No repair or replacement of Product or part thereof shall extend the Limited Warranty period as to the entire Product. Warranty on the repair part and workmanship shall only be effective for a period of ninety (90) days following the repair or replacement of that part or the remaining period of the Product Limited Warranty whichever is greater.

LIMITATION OF LIABILITY

IT IS UNDERSTOOD AND AGREED THAT INFOCUS' LIABILITY WHETHER IN CONTRACT, IN TORT, UNDER ANY WARRANTY, IN NEGLIGENCE OR OTHERWISE SHALL NOT EXCEED THE RETURN OF THE AMOUNT OF THE PURCHASE PRICE PAID BY PURCHASER AND UNDER NO CIRCUMSTANCES SHALL INFOCUS BE LIABLE FOR SPECIAL, INDIRECT, INCIDENTAL OR CONSEQUENTIAL DAMAGES OR LOST PROFITS, LOST REVENUES OR LOST SAVINGS. THE PRICE STATED FOR THE PRODUCTS IS A CONSIDERATION IN LIMITING INFOCUS' LIABILITY.

Limitation on Bringing Action - No action, regardless of form, arising out of the agreement to purchase the Product may be brought by purchaser more than one year after the cause of action has accrued.

Governing Law - Any action, regardless of form, arising out of the agreement to purchase the Product is governed by Oregon law.

Mandatory Arbitration - Any action, regardless of form, arising out of the agreement to purchase the Product is subject to mandatory arbitration.

SOME JURISDICTIONS DO NOT ALLOW THE EXCLUSION OR LIMITATION OF INCIDENTAL OR CONSEQUENTIAL DAMAGES SO THE ABOVE LIMITATION OR EXCLUSION MAY NOT APPLY TO YOU. THIS LIMITED WARRANTY GIVES YOU SPECIFIC LEGAL RIGHTS, AND YOU MAY ALSO HAVE OTHER RIGHTS, DEPENDING ON JURISDICTION.

Memo

A large, vertically oriented rounded rectangle with a solid blue border. Inside the rectangle, there are 25 horizontal dashed blue lines, evenly spaced, providing a guide for writing. The lines are light blue and extend across the width of the box.